

Output Feedback Stabilization of Networked Control Systems With Random Delays Modeled by Markov Chains

Yang Shi, *Member, IEEE*, and Bo Yu, *Student Member, IEEE*

Abstract—This note investigates the output feedback stabilization of networked control systems (NCSs). The sensor-to-controller (S-C) and controller-to-actuator (C-A) random network-induced delays are modeled as Markov chains. The focus is on the design of a two-mode-dependent controller that depends on not only the current S-C delay but also the most recent available C-A delay at the controller node. The resulting closed-loop system is transformed to a special discrete-time jump linear system. Then, the sufficient and necessary conditions for the stochastic stability are established. Further, the output feedback controller is designed via the iterative linear matrix inequality (LMI) approach. Simulation examples illustrate the effectiveness of the proposed method.

Index Terms—Jump linear system, Markov chains, networked control systems, packet dropout, random delays, stochastic stability.

I. INTRODUCTION

Networked control systems (NCSs) are a type of distributed control systems, where the information of control system components (reference input, plant output, control input, etc.) is exchanged via communication networks. NCSs have many attractive advantages, such as reduced system wiring, low weight and space, ease of system diagnosis and maintenance, and increased system agility, which motivate the research in NCSs. On the other hand, the introduction of networks also presents some constraints such as time delays and packet dropouts which bring difficulties for analysis and design of NCSs. The study of NCSs has been an active research area in the past several years, see [1]–[8], to name a few.

One of the constraints is the network-induced time delays, which can degrade the performance or even cause instability. Various methodologies have been proposed for modeling, stability analysis, and controller design for NCSs in the presence of network-induced time delays and packet dropouts. Generally, existing results can be classified into two main categories: 1) to design a controller first, and then determine the network conditions such as the maximum allowable transfer interval to guarantee the stability and maintain certain performance [2], [9], [10]; 2) to explicitly incorporate the network-induced delays using certain models, e.g., Markov process, into the controller design [1], [11]–[17]. The method developed in this note belongs to the latter.

The Markov chain, a discrete-time stochastic process with the Markov property, can be effectively used to model the network-induced delays in NCSs. In [1], the time delays of NCSs are modeled by using the Markov chains, and further an LQG optimal controller design method is proposed. Xiao *et al.* [11] propose two types of controller design methods for NCSs modeled as finite-dimensional, discrete-time jump linear systems: One is the state feedback controller that only depends on the delays from sensor to controller (S-C delays),

Manuscript received December 18, 2007; revised July 29, 2008, February 06, 2009, and March 03, 2009. First published June 23, 2009; current version published July 09, 2009. This work was supported by the Natural Sciences and Engineering Research Council of Canada. Recommended by Associate Editor S. Mascolo.

The authors are with the Department of Mechanical Engineering, University of Saskatchewan, Saskatoon, SK S7N 5A9, Canada (e-mail: yang.shi@usask.ca; yangshi@ieee.org; bo.yu@usask.ca).

Color versions of one or more of the figures in this technical note are available online at <http://ieeexplore.ieee.org>.

Digital Object Identifier 10.1109/TAC.2009.2020638

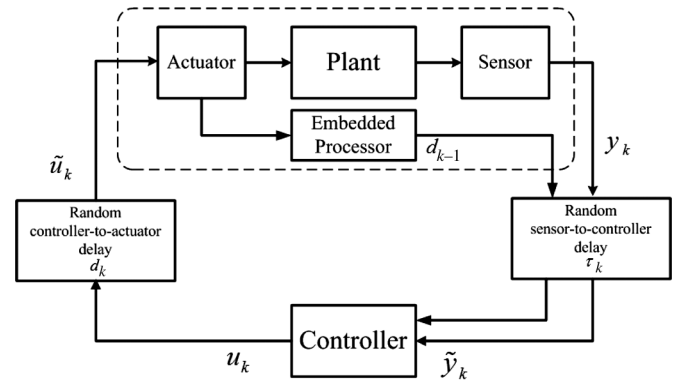

Fig. 1. Diagram of a networked control system.

and is called the one-mode-dependent controller; the other is the output feedback controller that does not depend on either the S-C delays or the C-A delays (delays from controller to actuator), and called the mode-independent controller. In [12], H_∞ control for NCSs is designed under the framework of Markovian jump linear systems (MJLSs) [18]–[21] based on the Bounded Real Lemma, but only the S-C delays are considered. In [15], a mode-independent state feedback controller is designed for NCSs subject to Markovian packet loss. In [16], the Markov chain is employed to model the packet loss and a one-mode-dependent state feedback controller is developed by introducing buffers to deal with the C-A packet loss.

In all the aforementioned references, the developed controllers are either mode-independent or one-mode-dependent, and the design problem can thus be readily converted into a standard MJLS problem [18]–[21]. To reduce the conservativeness of the stabilization conditions of an NCS, it is desirable to incorporate not only the S-C delay but also the C-A delay into the design. However, involving the C-A delay is complicated and challenging because the controller and actuator nodes are distributively located. Smart sensor technology [6], by adding a cost-effective embedded processor to the actuator node (Fig. 1), can process and calculate the C-A delay in real-time at the actuator node, and send this information to the controller node via the S-C communication medium. It is worthwhile noting that the transmission of the C-A delay information will also suffer from the S-C delay. Zhang *et al.* [13] propose a promising two-mode-dependent state feedback scheme to stabilize NCSs with S-C and C-A delays modeled as two Markov chains. In [13], it is assumed that at each sampling instant, the current S-C delay (τ_k) and previous C-A delay (d_{k-1}) can be obtained by the time-stamping technique. However, practically the previous C-A delay (d_{k-1}) is not always available because the information about C-A delays needs to be transmitted through the S-C communication link before reaching the controller, as shown in Fig. 1. In addition, when the full state information is not available, the state feedback controller in [13] cannot be directly applied. To the best of authors' knowledge, involving two network-induced delay modes to design the controller that simultaneously depends on both τ_k and $d_{k-\tau_k-1}$ has not been fully investigated, which is the focus of this work. When considering both τ_k and $d_{k-\tau_k-1}$, the resulting closed-loop system cannot be transformed to a standard MJLS, and thus the well-developed results on MJLSs [18]–[21] cannot be directly applied.

The rest of the note is organized as follows. In Section II, we analyze the available delay information and formulate the output feedback controller design problem. In Section III, the sufficient and necessary conditions to guarantee the stochastic stability are presented first and the

equivalent LMI conditions with constraints are derived. Simulation examples are given to illustrate the effectiveness of the proposed method in Section IV. The conclusion remarks are addressed in Section V.

II. PROBLEM FORMULATION

Consider the NCS setup in Fig. 1. The discrete-time linear time-invariant plant model is

$$x(k+1) = Ax(k) + B\tilde{u}(k) \quad (1a)$$

$$y(k) = Cx(k) \quad (1b)$$

where $x(k) \in \mathbb{R}^n$, $\tilde{u}(k) \in \mathbb{R}^m$, $y(k) \in \mathbb{R}^p$, and A , B , and C are known real matrices with appropriate dimensions. Bounded random delays exist in both links from sensor to controller and controller to actuator, as shown in Fig. 1. Here, $\tau \geq \tau_k \geq 0$ represents the S-C delay and $d \geq d_k \geq 0$ stands for the C-A delay. The output feedback controller is to be designed.

A. Delays Modeled by Markov Chains

One way to model the delays τ_k and d_k is to use the finite state Markov chain as in [1], [11], [13]. The main advantages of the Markov model are: 1) the dependencies between delays are taken into account since in real networks the current time delays are usually related with the previous delays [1] and 2) the packet dropout could be included naturally [11]. In this note, τ_k and d_k are modeled as two homogeneous Markov chains that take values in $\mathcal{M} = \{0, 1, \dots, \tau\}$ and $\mathcal{N} = \{0, 1, \dots, d\}$, and their transition probability matrices are $\Lambda = [\lambda_{ij}]$ and $\Pi = [\pi_{rs}]$, respectively. That means τ_k and d_k jump from mode i to j and from mode r to s , respectively, with probabilities λ_{ij} and π_{rs} :

$$\lambda_{ij} = \Pr(\tau_{k+1} = j | \tau_k = i), \quad \pi_{rs} = \Pr(d_{k+1} = s | d_k = r)$$

where $\lambda_{ij}, \pi_{rs} \geq 0$ and

$$\sum_{j=0}^{\tau} \lambda_{ij} = 1, \quad \sum_{s=0}^d \pi_{rs} = 1$$

for all $i, j \in \mathcal{M}$ and $r, s \in \mathcal{N}$.

B. Two-Mode-Dependent Output Feedback Controller

In NCSs, the delay information is important for the controller design. For the controller node, at time instant k , τ_k can be obtained by comparing the current time and the time-stamp of the sensor information received. Similarly, at the actuator node, the embedded processor can compare the current time with the time-stamp of the control signal received to calculate the C-A delay information d_{k-1} at current time k . However, this information cannot be received by the controller immediately, because it needs to be transmitted through the network from sensor to controller. So if the time delay τ_k exists, the information of $d_{k-\tau_k-1}$ at time instant k would be known at the controller node. Specially, if $\tau_k = 0$, d_{k-1} is available at the controller node. Consequently, it is desirable to design the output feedback controller that simultaneously depends on both τ_k and $d_{k-\tau_k-1}$. The dynamic output feedback control law is

$$z(k+1) = F(\tau_k, d_{k-\tau_k-1})z(k) + G(\tau_k, d_{k-\tau_k-1})\tilde{y}(k) \quad (2a)$$

$$u(k) = H(\tau_k, d_{k-\tau_k-1})z(k) + J(\tau_k, d_{k-\tau_k-1})\tilde{y}(k) \quad (2b)$$

where $z(k) \in \mathbb{R}^n$ is the state vector of the output feedback controller; and F , G , H , and J are appropriately dimensioned matrices to be designed. Clearly, the controller in (2) is two-mode-dependent.

C. Closed-Loop System

Considering the time delay in the S-C link, we have

$$x(k+1) = Ax(k) + B\tilde{u}(k), \quad (3a)$$

$$\tilde{y}(k) = y(k - \tau_k) = Cx(k - \tau_k). \quad (3b)$$

Augment the plant's state and output as

$$\tilde{X}(k) = [x(k)^T \ y(k-1)^T \ y(k-2)^T \ \dots \ y(k-\tau)^T]^T$$

then we have

$$\tilde{X}(k+1) = \tilde{A}\tilde{X}(k) + \tilde{B}\tilde{u}(k) \quad (4a)$$

$$\tilde{y}(k) = \tilde{C}(\tau_k)\tilde{X}(k) \quad (4b)$$

where

$$\tilde{A} = \begin{bmatrix} A & 0 & \dots & 0 & 0 \\ C & 0 & \dots & 0 & 0 \\ 0 & I & \dots & 0 & 0 \\ \vdots & \vdots & \ddots & \vdots & \vdots \\ 0 & 0 & \dots & I & 0 \end{bmatrix}, \quad \tilde{B} = \begin{bmatrix} B \\ 0 \\ \vdots \\ 0 \\ 0 \end{bmatrix}$$

$$\tilde{C}(\tau_k) = \begin{cases} [C \ 0 \ \dots \ 0 \ 0 \ \dots \ 0], & \text{for } \tau(k) = 0 \\ [0 \ \dots \ 0 \ I \ 0 \ \dots \ 0] & \text{for } \tau(k) > 0. \end{cases}$$

(1+ τ_k)th block being identity

Similarly, define

$$\tilde{Z}(k) = [z(k)^T \ u(k-1)^T \ u(k-2)^T \ \dots \ u(k-d)^T]^T$$

then

$$\tilde{Z}(k+1) = \tilde{F}(\tau_k, d_{k-\tau_k-1})\tilde{Z}(k) + \tilde{G}(\tau_k, d_{k-\tau_k-1})\tilde{y}(k) \quad (5a)$$

$$\tilde{u}(k) = \tilde{H}(\tau_k, d_k, d_{k-\tau_k-1})\tilde{Z}(k) + \tilde{J}(\tau_k, d_k, d_{k-\tau_k-1})\tilde{y}(k) \quad (5b)$$

where

$$\tilde{F}(\tau_k, d_{k-\tau_k-1}) = \begin{bmatrix} F(\tau_k, d_{k-\tau_k-1}) & 0 & \dots & 0 & 0 \\ H(\tau_k, d_{k-\tau_k-1}) & 0 & \dots & 0 & 0 \\ 0 & I & \dots & 0 & 0 \\ \vdots & \vdots & \ddots & \vdots & \vdots \\ 0 & 0 & \dots & I & 0 \end{bmatrix}$$

$$\tilde{G}(\tau_k, d_{k-\tau_k-1}) = \begin{bmatrix} G(\tau_k, d_{k-\tau_k-1}) \\ J(\tau_k, d_{k-\tau_k-1}) \\ \vdots \\ 0 \\ 0 \end{bmatrix}$$

$$\tilde{H}(\tau_k, d_k, d_{k-\tau_k-1}) = \begin{cases} [H(\tau_k, d_{k-\tau_k-1}) \ 0 \ \dots \ 0 \ 0 \ \dots \ 0], & \text{for } d(k) = 0 \\ [0 \ \dots \ 0 \ I \ 0 \ \dots \ 0] & \text{for } d(k) > 0, \end{cases}$$

(1+ d_k)th block being identity

$$\tilde{J}(\tau_k, d_k, d_{k-\tau_k-1}) = \begin{cases} J(\tau_k, d_{k-\tau_k-1}), & \text{for } d(k) = 0 \\ 0, & \text{for } d(k) > 0. \end{cases}$$

By combining (4) and (5) and defining

$$X(k) = \begin{bmatrix} \hat{X}(k)^\top & \hat{Z}(k)^\top \end{bmatrix}^\top$$

the closed-loop system can be written as

$$X(k+1) = [\bar{A} + \bar{B}K(\tau_k, d_k, d_{k-\tau_k-1})\bar{C}(\tau_k)]X(k) \quad (6)$$

where

$$\begin{aligned} \bar{A} &= \begin{bmatrix} \bar{A} & 0 \\ 0 & 0 \end{bmatrix}, \quad \bar{B} = \begin{bmatrix} 0 & \bar{B} \\ I & 0 \end{bmatrix}, \quad \bar{C}(\tau_k) = \begin{bmatrix} 0 & I \\ \tilde{C}(\tau_k) & 0 \end{bmatrix} \\ K(\tau_k, d_k, d_{k-\tau_k-1}) &= \begin{bmatrix} \hat{F}(\tau_k, d_k, d_{k-\tau_k-1}) & \hat{G}(\tau_k, d_k, d_{k-\tau_k-1}) \\ \hat{H}(\tau_k, d_k, d_{k-\tau_k-1}) & \hat{J}(\tau_k, d_k, d_{k-\tau_k-1}) \end{bmatrix}. \end{aligned}$$

Remark 1: By applying the proposed two-mode-dependent controller in (2), the resulting closed-loop system in (6) cannot be transformed to a standard MJLS, because the closed-loop system depends on τ_k , d_k , and $d_{k-\tau_k-1}$. In addition, $d_{k-\tau_k-1}$ is related with both τ_k and d_k . This makes the analysis and design more challenging, and this two-mode-dependent controller design has not been investigated in the literature.

The objective of this note is: Design the output feedback controller to guarantee the stochastic stability of the NCS in (6). For the stochastic stability, we adopt the definition in [13].

Definition 1: The system in (6) is stochastically stable if for every finite $X_0 = X(0)$, initial mode $\tau_0 = \tau(0) \in \mathcal{M}$, and $d_{-\tau_0-1} = d(-\tau_0 - 1) \in \mathcal{N}$, there exists a finite $W > 0$ such that the following holds:

$$\mathcal{E} \left\{ \sum_{k=0}^{\infty} \|X(k)\|^2 \mid X_0, \tau_0, d_{-\tau_0-1} \right\} < X_0^\top W X_0. \quad (7)$$

III. MAIN RESULTS

In this section, we first give the sufficient and necessary conditions for the output feedback stabilization of system in (6), and then derive the equivalent conditions of LMIs with nonconvex constraints.

As $d_{k-\tau_k-1}$ is to be incorporated into the controller design, the multi-step jump of Markov chains is involved in the system evolution. Then, a natural question is: What is the transition probability matrix for the multi-step delay mode jump? This is of great importance for the derivation of sufficient and necessary conditions for designing the output feedback controller later soon. To answer this, we give Proposition 1 as follows.

Proposition 1: If the transition probability matrix from d_{k-1} to d_k is Π , then the transition probability matrix from $d_{k-\tau_{k+1}}$ to d_k is $\Pi^{\tau_{k+1}}$, which is still a transition probability matrix of the Markov chain. Specially, when $\tau_{k+1} = 0$, the transition probability matrix is $\Pi^{\tau_{k+1}} = \Pi^0 = I$.

Proof: The transition probability matrix from $d_{k-\tau_{k+1}}$ to d_k is in the equation, shown at the bottom of the page. A special case is that when $\tau_{k+1} = 0$, then $\Pi_{\tau_{k+1}} = \Pi^{\tau_{k+1}} = I$. This completes the proof. ■

The sufficient and necessary conditions to guarantee the stochastic stability of system in (6) can be derived with Definition 1, which are shown in Theorem 1. For the ease of presentation, when the system is in mode $i \in \mathcal{M}$ and $r \in \mathcal{N}$ (i.e., $\tau_k = i$, $d_{k-\tau_k-1} = r$), we denote $F(\tau_k, d_{k-\tau_k-1})$, $G(\tau_k, d_{k-\tau_k-1})$, $H(\tau_k, d_{k-\tau_k-1})$, and $J(\tau_k, d_{k-\tau_k-1})$ as $F(i, r)$, $G(i, r)$, $H(i, r)$, and $J(i, r)$, respectively.

Theorem 1: Under the proposed output feedback control law (2), the resulting closed-loop system in (6) is stochastically stable if and only if there exists symmetric $P(i, r) > 0$ such that the following matrix inequality:

$$\begin{aligned} L(i, r) &= \sum_{j=0}^{\tau} \sum_{s_1=0}^d \sum_{s_2=0}^d \lambda_{ij} \Pi_r^{1+i-j} \Pi_{s_2}^j \\ &\quad \times [\bar{A} + \bar{B}K(i, s_1, r)\bar{C}(i)]^\top P(j, s_2) \\ &\quad \times [\bar{A} + \bar{B}K(i, s_1, r)\bar{C}(i)] - P(i, r) \\ &< 0 \end{aligned} \quad (8)$$

holds for all $i \in \mathcal{M}$ and $r \in \mathcal{N}$.

Proof: Sufficiency: For the closed-loop system in (6), construct the Lyapunov function

$$V(X(k), k) = X(k)^\top P(\tau_k, d_{k-\tau_k-1}) X(k).$$

Then

$$\begin{aligned} \mathcal{E} \{ \Delta(V(X(k), k)) \} &= \mathcal{E} \{ V(X(k+1), k+1) - V(X(k), k) \} \\ &= \mathcal{E} \left\{ X(k+1)^\top P(\tau_{k+1}, d_{k-\tau_{k+1}}) X(k+1) \right. \\ &\quad \left. \mid X_k, \tau_k = i, d_{k-\tau_k-1} = r \right\} \\ &\quad - X(k)^\top P(\tau_k, d_{k-\tau_k-1}) X(k). \end{aligned} \quad (9)$$

Define $\tau_{k+1} = j$, $d_k = s_1$, $d_{k-\tau_{k+1}} = s_2$. To evaluate the first term in (9), we need to apply the probability transition matrices for $\tau_k \rightarrow \tau_{k+1}$, $d_{k-i-1} \rightarrow d_{k-j}$, and $d_{k-j} \rightarrow d_k$, respectively. According to Proposition 1, these three probability transition matrices are

$$\tau_k \rightarrow \tau_{k+1} : \Lambda, \quad d_{k-i-1} \rightarrow d_{k-j} : \Pi^{1+i-j}, \quad d_{k-j} \rightarrow d_k : \Pi^j.$$

Then, (9) can be evaluated as

$$\begin{aligned} \mathcal{E} \{ \Delta(V(X(k), k)) \} &= X(k)^\top \left\{ \sum_{j=0}^{\tau} \sum_{s_1=0}^d \sum_{s_2=0}^d \lambda_{ij} \Pi_r^{1+i-j} \Pi_{s_2}^j \right. \\ &\quad \times [\bar{A} + \bar{B}K(i, s_1, r)\bar{C}(i)]^\top P(j, s_2) \\ &\quad \left. \times [\bar{A} + \bar{B}K(i, s_1, r)\bar{C}(i)] - P(i, r) \right\} X(k). \end{aligned} \quad (10)$$

Thus, if $L(i, r) < 0$, then

$$\begin{aligned} \mathcal{E} \{ \Delta(V(X(k), k)) \} &= X(k)^\top L(i, r) X(k) \\ &\leq -\lambda_{\min}(-L(i, r)) X(k)^\top X(k) \\ &\leq -\beta \|X(k)\|^2 \end{aligned} \quad (11)$$

$$\sum_{j_{\tau_{k+1}}=0}^d \cdots \sum_{j_3=0}^d \sum_{j_2=0}^d \begin{bmatrix} \pi_{0j_2} \pi_{j_2 j_3} \cdots \pi_{j_{\tau_{k+1}} 0} & \pi_{0j_2} \pi_{j_2 j_3} \cdots \pi_{j_{\tau_{k+1}} 1} & \cdots & \pi_{0j_2} \pi_{j_2 j_3} \cdots \pi_{j_{\tau_{k+1}} d} \\ \pi_{1j_2} \pi_{j_2 j_3} \cdots \pi_{j_{\tau_{k+1}} 0} & \pi_{1j_2} \pi_{j_2 j_3} \cdots \pi_{j_{\tau_{k+1}} 1} & \cdots & \pi_{1j_2} \pi_{j_2 j_3} \cdots \pi_{j_{\tau_{k+1}} d} \\ \vdots & \vdots & \ddots & \vdots \\ \pi_{dj_2} \pi_{j_2 j_3} \cdots \pi_{j_{\tau_{k+1}} 0} & \pi_{dj_2} \pi_{j_2 j_3} \cdots \pi_{j_{\tau_{k+1}} 1} & \cdots & \pi_{dj_2} \pi_{j_2 j_3} \cdots \pi_{j_{\tau_{k+1}} d} \end{bmatrix} = \Pi^{\tau_{k+1}}.$$

where $\beta = \inf\{\lambda_{\min}(-L(i, r))\} > 0$. From (11), we can see that for any $T \geq 1$

$$\mathcal{E}\{V(X(T+1), T+1)\} - \mathcal{E}\{V(X_0, 0)\} \leq -\beta \mathcal{E}\left\{\sum_{t=0}^T \|X(t)\|^2\right\}.$$

Furthermore

$$\begin{aligned} \mathcal{E}\left\{\sum_{t=0}^T \|X(t)\|^2\right\} &\leq \frac{1}{\beta} (\mathcal{E}\{V(X_0, 0)\} \\ &\quad - \mathcal{E}\{V(X(T+1), T+1)\}) \\ &\leq \frac{1}{\beta} \mathcal{E}\{V(X_0, 0)\} \\ &= \frac{1}{\beta} X(0)^T P(\tau_0, d_{-\tau_0-1}) X(0). \end{aligned}$$

According to Definition 1, the closed-loop system in (6) is stochastically stable.

Necessity: For necessity, we need to show that if the system in (6) is stochastically stable, then there exists symmetric $P(i, r) > 0$ such that (8) holds. It suffices to prove that for any bounded and symmetric $Q(\tau_k, d_{k-\tau_k-1}) > 0$, there exists a set of $P(\tau_k, d_{k-\tau_k-1})$ such that

$$\sum_{j=0}^{\tau} \sum_{s_1=0}^d \sum_{s_2=0}^d \lambda_{ij} \Pi_{rs_2}^{1+i-j} \Pi_{s_2 s_1}^j [\bar{A} + \bar{B}K(i, s_1, r)\bar{C}(i)]^T \times P(j, s_2) [\bar{A} + \bar{B}K(i, s_1, r)\bar{C}(i)] - P(i, r) = -Q(i, r).$$

Define

$$\begin{aligned} X(t)^T \bar{P}(T-t, \tau_t, d_{t-\tau_t-1}) X(t) \\ \triangleq \mathcal{E}\left\{\sum_{k=t}^T X(k)^T Q(\tau_k, d_{k-\tau_k-1}) X(k) \Big|_{X_t, \tau_t, d_{t-\tau_t-1}}\right\}. \end{aligned}$$

Assuming that $X(k) \neq 0$, since $Q(\tau_k, d_{k-\tau_k-1}) > 0$, as T increases, $X(t)^T \bar{P}(T-t, \tau_t, d_{t-\tau_t-1}) X(t)$ is monotonically increasing, or else it increases monotonically until $\mathcal{E}\{X(k)^T Q(\tau_k, d_{k-\tau_k-1}) X(k) \Big|_{X_t, \tau_t, d_{t-\tau_t-1}}\} = 0$ for all $k \geq k_1 \geq t$. From (7), $X(t)^T \bar{P}(T-t, \tau_t, d_{t-\tau_t-1}) X(t)$ is upper bounded. Furthermore, its limit exists and can be expressed as

$$\begin{aligned} X(t)^T P(i, r) X(t) \\ \triangleq \lim_{T \rightarrow \infty} X(t)^T \bar{P}(T-t, \tau_t = i, d_{t-\tau_t-1} = r) X(t) \\ \triangleq \lim_{T \rightarrow \infty} \mathcal{E}\left\{\sum_{k=t}^T X(k)^T Q(\tau_k, d_{k-\tau_k-1}) X(k) \Big|_{X_t, \tau_t = i, d_{t-\tau_t-1} = r}\right\}. \end{aligned} \quad (12)$$

Since this is valid for any $X(t)$, we have

$$P(i, r) = \lim_{T \rightarrow \infty} \bar{P}(T-t, \tau_t = i, d_{t-\tau_t-1} = r). \quad (13)$$

From (12), we obtain $P(i, r) > 0$ since $Q(\tau_k, d_{k-\tau_k-1}) > 0$. Consider

$$\begin{aligned} \mathcal{E}\left\{X(t)^T \bar{P}(T-t, \tau_t, d_{t-\tau_t-1}) X(t) - X(t+1)^T \bar{P} \right. \\ \left. \times (T-t-1, \tau_{t+1}, d_{t-\tau_{t+1}}) X(t+1) \Big|_{X_t, \tau_t = i, d_{t-\tau_t-1} = r}\right\} \\ = X(t)^T Q(i, r) X(t). \end{aligned} \quad (14)$$

By using Proposition 1, the second term in (14) can be evaluated as

$$\begin{aligned} \mathcal{E}\left\{X(t+1)^T \bar{P}(T-t-1, \tau_{t+1}, d_{t-\tau_{t+1}}) X(t+1) \Big|_{X_t, \tau_t, d_{t-\tau_t-1}}\right\} \\ = X(t)^T \left\{\sum_{j=0}^{\tau} \sum_{s_1=0}^d \sum_{s_2=0}^d \lambda_{ij} \Pi_{rs_2}^{1+i-j} \Pi_{s_2 s_1}^j \right. \\ \left. \times [\bar{A} + \bar{B}K(i, s_1, r)\bar{C}(i)]^T \bar{P}(T-t-1, j, s_2) \right. \\ \left. \times [\bar{A} + \bar{B}K(i, s_1, r)\bar{C}(i)]\right\} X(t). \end{aligned} \quad (15)$$

Substituting (15) into (14) gives rise to

$$\begin{aligned} X(t)^T \left\{\bar{P}(T-t, \tau_t, d_{t-\tau_t-1}) \right. \\ \left. - \sum_{j=0}^{\tau} \sum_{s_1=0}^d \sum_{s_2=0}^d \lambda_{ij} \Pi_{rs_2}^{1+i-j} \Pi_{s_2 s_1}^j \right. \\ \left. \times [\bar{A} + \bar{B}K(i, s_1, r)\bar{C}(i)]^T \bar{P}(T-t-1, j, s_2) \right. \\ \left. \times [\bar{A} + \bar{B}K(i, s_1, r)\bar{C}(i)]\right\} \times X(t) \\ = X(t)^T Q(i, r) X(t). \end{aligned} \quad (16)$$

Letting $T \rightarrow \infty$ and noticing (13), it is shown that (8) holds. This completes the proof. \blacksquare

Theorem 1 gives the sufficient and necessary conditions on the existence of the output feedback controller. However, the conditions in (8) are nonlinear in the controller matrices. To handle this, the equivalent LMI conditions with nonconvex constraints are given in Proposition 2.

Proposition 2: There exists a controller (2) such that the closed-loop system in (6) is stochastically stable if and only if there exist matrices $F(i, r)$, $G(i, r)$, $H(i, r)$, $J(i, r)$, and symmetric matrices $\bar{X}(j, s_2) > 0$, $P(i, r) > 0$, satisfying

$$\begin{bmatrix} -P(i, r) & V(i, r)^T \\ V(i, r) & -X(i, r) \end{bmatrix} < 0 \quad (17a)$$

$$\bar{X}(j, s_2) P(j, s_2) = I \quad (17b)$$

for all $i, j \in \mathcal{M}$ and $r, s_2 \in \mathcal{N}$, with

$$\begin{aligned} V(i, r) &= [V_0(i, r)^T \ V_1(i, r)^T \ \cdots \ V_\tau(i, r)^T]^T \\ V_j(i, r) &= [V_{j,0}(i, r)^T \ V_{j,1}(i, r)^T \ \cdots \ V_{j,d}(i, r)^T]^T \\ V_{j,s_2}(i, r) &= \begin{bmatrix} (\lambda_{ij} \Pi_{rs_2}^{1+i-j} \Pi_{s_2 0}^j)^{\frac{1}{2}} [\bar{A} + \bar{B}K(i, 0, r)\bar{C}(i)] \\ (\lambda_{ij} \Pi_{rs_2}^{1+i-j} \Pi_{s_2 1}^j)^{\frac{1}{2}} [\bar{A} + \bar{B}K(i, 1, r)\bar{C}(i)] \\ \vdots \\ (\lambda_{ij} \Pi_{rs_2}^{1+i-j} \Pi_{s_2 d}^j)^{\frac{1}{2}} [\bar{A} + \bar{B}K(i, d, r)\bar{C}(i)] \end{bmatrix} \\ X(i, r) &= \text{diag}\{X_0(i, r) \ X_1(i, r) \ \cdots \ X_\tau(i, r)\} \\ X_j(i, r) &= \text{diag}\{X_{j,0}(i, r) \ X_{j,1}(i, r) \ \cdots \ X_{j,d}(i, r)\} \\ X_{j,s_2}(i, r) &= \text{diag}\left\{\underbrace{\bar{X}(j, s_2) \ \bar{X}(j, s_2) \ \cdots \ \bar{X}(j, s_2)}_{d+1}\right\}. \end{aligned}$$

Proof: By applying the Schur complement and letting $\bar{X}(j, s_2) = P(j, s_2)^{-1}$, the proof can be readily completed. \blacksquare

The conditions in Proposition 2 are a set of LMIs with nonconvex constraints. This can be solved by several existing iterative LMI algorithms. It was shown in [22] that the product reduction algorithm (PRA) is the best and seldom fails to find a global optimum. Thus, PRA [23] is employed to solve the conditions (17).

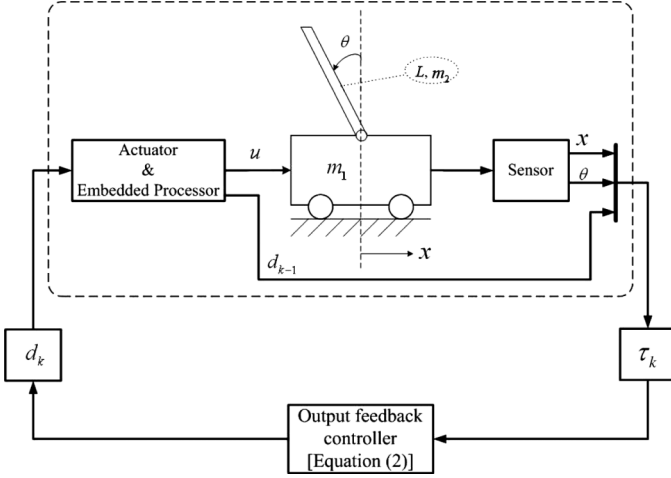

Fig. 2. Cart and inverted pendulum system.

Remark 2: The two-mode-dependent controller (2) makes full use of the delay information by involving both the S-C and C-A delays. Moreover, it includes the one-mode-dependent and mode-independent controllers as special cases. When $F(\tau_k, d_{k-\tau_k-1}) = F_1(\tau_k)$, $G(\tau_k, d_{k-\tau_k-1}) = G_1(\tau_k)$, $H(\tau_k, d_{k-\tau_k-1}) = H_1(\tau_k)$, $J(\tau_k, d_{k-\tau_k-1}) = J_1(\tau_k) \forall d_{k-\tau_k-1} \in \mathcal{N}$, the controller (2) is reduced to be one-mode-dependent. When $F(\tau_k, d_{k-\tau_k-1}) = F_0$, $G(\tau_k, d_{k-\tau_k-1}) = G_0$, $H(\tau_k, d_{k-\tau_k-1}) = H_0$, $J(\tau_k, d_{k-\tau_k-1}) = J_0 \forall \tau_k \in \mathcal{M}$, and $d_{k-\tau_k-1} \in \mathcal{N}$, the controller (2) becomes a mode-independent one. Theorem 1 and Proposition 2 can also handle the one-mode-dependent and mode-independent controller design problems as special cases.

IV. NUMERICAL EXAMPLE

To illustrate the effectiveness of the proposed method, we apply the results in Section III to a cart and inverted pendulum system [11], [13] shown in Fig. 2, where x_d is the position of the cart, θ is the angular position of the pendulum, and u is the input force. The state variables are chosen as $[x_d \dot{x}_d \theta \dot{\theta}]^T$. The output is $y = [x_d \theta]^T$. We assume that the surface is frictionless and the system parameters are: $m_1 = 1$ kg, $m_2 = 0.5$ kg, $L = 1$ m. The output feedback controller is designed for the following linearized discrete-time model with sampling time $T_s = 0.1$ s:

$$A_d = \begin{bmatrix} 1.0000 & 0.1000 & -0.0166 & -0.0005 \\ 0 & 1.0000 & -0.3374 & -0.0166 \\ 0 & 0 & 1.0996 & 0.1033 \\ 0 & 0 & 2.0247 & 1.0996 \end{bmatrix}$$

$$B_d = \begin{bmatrix} 0.0045 \\ 0.0896 \\ -0.0068 \\ -0.1377 \end{bmatrix}, \quad C_d = \begin{bmatrix} 1 & 0 & 0 & 0 \\ 0 & 0 & 1 & 0 \end{bmatrix}.$$

The eigenvalues of A_d are 1, 1, 1.5569, and 0.6423. Hence, the discrete-time system is unstable.

The random delays involved in this NCS are assumed to be $\tau_k \in \{0, 1, 2\}$ and $d_k \in \{0, 1\}$, and their transition probability matrices are given by

$$\Lambda = \begin{bmatrix} 0.6 & 0.4 & 0 \\ 0.5 & 0.4 & 0.1 \\ 0.5 & 0.4 & 0.1 \end{bmatrix}, \quad \Pi = \begin{bmatrix} 0.4 & 0.6 \\ 0.5 & 0.5 \end{bmatrix}.$$

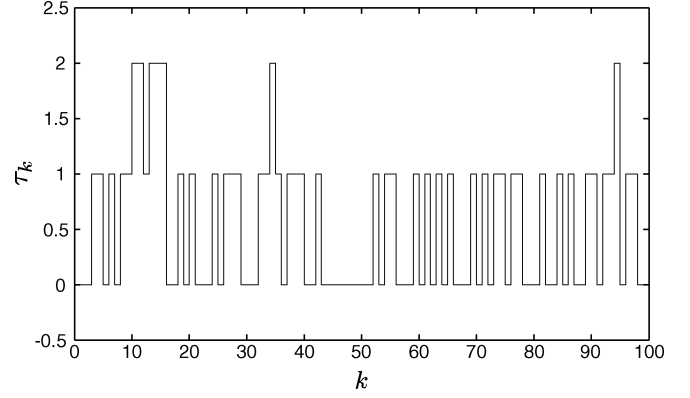
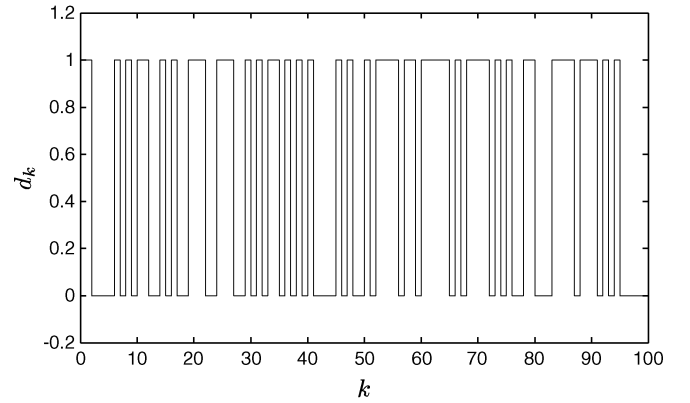
Fig. 3. S-C random delays τ_k .Fig. 4. C-A random delays d_k .

Figs. 3 and 4 show part of the simulation run of the S-C delays τ_k and C-A delays d_k governed by their corresponding transition probability matrices, respectively.

Based on Proposition 1, the transition probability matrix for the delay mode jumping from d_{k-2} to d_k is Π^2 . By using Proposition 2, we design the two-mode-dependent output feedback controller with the following matrices: $F(\tau_k, d_{k-\tau_k-1})$, $G(\tau_k, d_{k-\tau_k-1})$, $H(\tau_k, d_{k-\tau_k-1})$, and $J(\tau_k, d_{k-\tau_k-1})$

$$F(0, 0) = \begin{bmatrix} 0.2904 & -0.0507 & 0.2873 & -0.0678 \\ -0.0454 & -0.1453 & -0.0663 & 0.8348 \\ 0.3473 & 0.2992 & 0.7629 & -0.1335 \\ 0.2954 & -0.5019 & -0.1940 & 0.6189 \end{bmatrix}$$

$$G(0, 0) = \begin{bmatrix} 0.1266 & -2.5019 \\ 0.0064 & 6.9785 \\ -0.1025 & 0.0202 \\ 0.0046 & 2.7688 \end{bmatrix}$$

$$H(0, 0) = [0.8166 \quad -1.4260 \quad -0.1488 \quad 4.6258]$$

$$J(0, 0) = [-0.3551 \quad 34.4373]$$

$$F(0, 1) = \begin{bmatrix} 0.2811 & -0.0411 & 0.2919 & -0.0648 \\ -0.0628 & -0.1621 & -0.0609 & 0.8579 \\ 0.3313 & 0.2801 & 0.7671 & -0.1179 \\ 0.3111 & -0.5060 & -0.2006 & 0.6093 \end{bmatrix}$$

$$G(0, 1) = \begin{bmatrix} 0.1273 & -2.5833 \\ 0.0082 & 7.0448 \\ -0.1003 & 0.0825 \\ 0.0032 & 2.8371 \end{bmatrix}$$

$$H(0, 1) = [0.6793 \quad -1.5327 \quad -0.0954 \quad 4.8149]$$

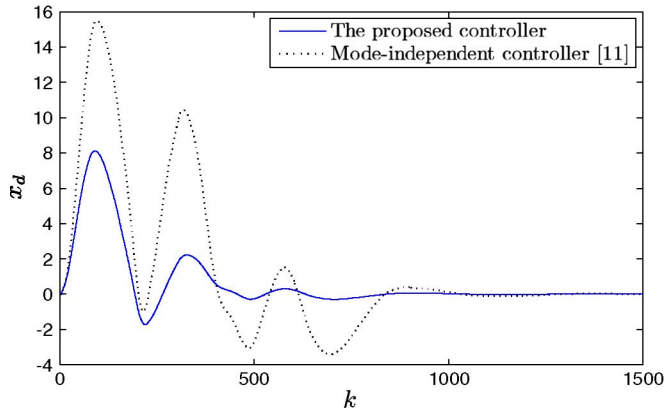

Fig. 5. Response of x_d .

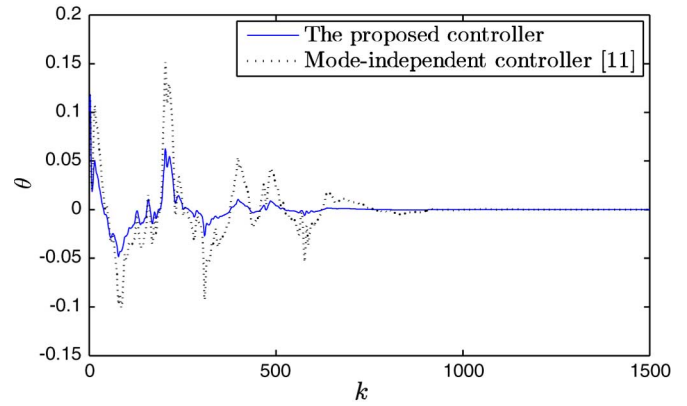

Fig. 7. Response of θ .

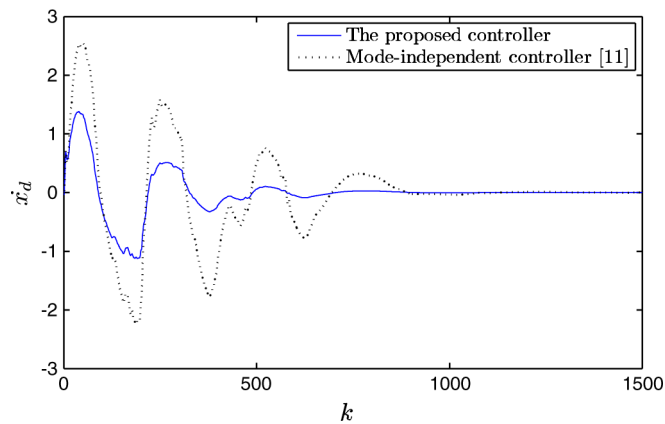

Fig. 6. Response of \dot{x}_d .

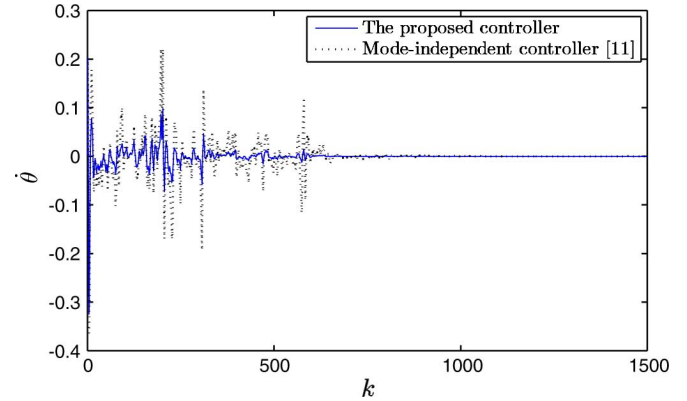

Fig. 8. Response of $\dot{\theta}$.

$$\begin{aligned}
 J(0,1) &= [-0.3406 \quad 34.8353] \\
 F(1,0) &= \begin{bmatrix} 0.4330 & 0.0191 & 0.2820 & -0.2111 \\ -0.1391 & -0.1432 & 0.0243 & 0.9575 \\ 0.0901 & 0.2095 & 0.8207 & 0.0818 \\ 0.2713 & -0.5090 & -0.1746 & 0.6518 \end{bmatrix} \\
 G(1,0) &= \begin{bmatrix} 0.1268 & -2.6224 \\ 0.0277 & 6.7524 \\ -0.0865 & -0.0867 \\ 0.0093 & 2.7467 \end{bmatrix} \\
 H(1,0) &= [0.2472 \quad -1.5821 \quad 0.0696 \quad 5.2399] \\
 J(1,0) &= [-0.3062 \quad 34.1695] \\
 F(1,1) &= \begin{bmatrix} 0.4404 & 0.0008 & 0.2719 & -0.2012 \\ -0.1554 & -0.1654 & 0.0259 & 0.9732 \\ 0.1373 & 0.2251 & 0.8002 & 0.0694 \\ 0.2806 & -0.5140 & -0.1814 & 0.6543 \end{bmatrix} \\
 G(1,1) &= \begin{bmatrix} 0.1240 & -2.4783 \\ 0.0293 & 6.8387 \\ -0.0950 & -0.0005 \\ 0.0071 & 2.8179 \end{bmatrix} \\
 H(1,1) &= [0.1836 \quad -1.5791 \quad 0.1049 \quad 5.2547] \\
 J(1,1) &= [-0.2943 \quad 33.9318] \\
 F(2,0) &= \begin{bmatrix} 0.4305 & 0.0021 & 0.3265 & -0.1969 \\ -0.1601 & -0.1434 & 0.0990 & 0.9299 \\ 0.0017 & 0.1798 & 0.7885 & 0.1621 \\ 0.2832 & -0.5032 & -0.1594 & 0.6238 \end{bmatrix}
 \end{aligned}$$

$$\begin{aligned}
 G(2,0) &= \begin{bmatrix} 0.1414 & -2.6186 \\ 0.0551 & 6.5064 \\ -0.0981 & 0.0391 \\ 0.0157 & 2.6733 \end{bmatrix} \\
 H(2,0) &= [0.1315 \quad -1.5662 \quad 0.1001 \quad 5.2564] \\
 J(2,0) &= [-0.2946 \quad 33.7758] \\
 F(2,1) &= \begin{bmatrix} 0.5172 & 0.0423 & 0.2994 & -0.2514 \\ -0.1345 & -0.1372 & 0.0909 & 0.9492 \\ 0.0241 & 0.1588 & 0.8051 & 0.1574 \\ 0.2509 & -0.5249 & -0.1479 & 0.6705 \end{bmatrix} \\
 G(2,1) &= \begin{bmatrix} 0.1307 & -2.6505 \\ 0.0490 & 6.5676 \\ -0.0919 & 0.1145 \\ 0.0183 & 2.7559 \end{bmatrix} \\
 H(2,1) &= [0.1887 \quad -1.5291 \quad 0.0882 \quad 5.1969] \\
 J(2,1) &= [-0.2989 \quad 33.6056].
 \end{aligned}$$

The initial values of the discrete-time model and the output feedback controller are $x(-3) = x(-2) = x(-1) = [0 \ 0 \ 0 \ 0]^T$, $x(0) = [0 \ 0 \ 0.1 \ 0]^T$, and $z(-2) = z(-1) = z(0) = [0 \ 0 \ 0 \ 0]^T$. For the purpose of comparison, the mode-independent output feedback controller [11] is applied to the same system. Figs. 5–8 illustrate the responses of four states using the proposed two-mode-dependent controller and the mode-independent controller, respectively. It is observed that the

proposed two-mode-dependent controller outperforms the mode-independent one [11].

V. CONCLUSION

This note proposes an output feedback controller design method for NCSs with random network-induced delays. The S-C and C-A delays, modeled by two Markov chains, are simultaneously incorporated into the controller design in a general and practical way. Then the resulting closed-loop system is a special discrete-time jump linear systems. The sufficient and necessary conditions of the stochastic stability are derived in the form of a set of LMIs with nonconvex constraints. The product reduction algorithm is employed to obtain the two-mode-dependent output feedback controller. Simulation examples verify its effectiveness. It is worth mentioning that the proposed two-mode-dependent controller can be extended to consider the control performance and system uncertainties.

ACKNOWLEDGMENT

The authors wish to thank the anonymous reviewers and the associate editor for providing constructive suggestions which have improved the presentation of the technical note.

REFERENCES

- [1] J. Nilsson, "Real-Time Control Systems With Delays," Ph.D. dissertation, Lund Institute of Technology, Lund, Sweden, 1998.
- [2] W. Zhang, M. S. Branicky, and S. M. Phillips, "Stability of networked control systems," *IEEE Control Syst. Mag.*, vol. 21, no. 1, pp. 84–99, Feb. 2001.
- [3] Y. Shi, H. Fang, and M. Yan, "Kalman filter based adaptive control for networked systems with unknown parameters and randomly missing outputs," *Int. J. Robust Nonlin. Control (Special Issue on Control With Limited Information)*, 2009, 10.1002/rnc.1390.
- [4] G. C. Walsh, H. Ye, and L. G. Bushnell, "Stability analysis of networked control systems," *IEEE Trans. Control Syst. Technol.*, vol. 10, no. 3, pp. 438–446, May 2002.
- [5] Y. Tipsuwan and M.-Y. Chow, "Control methodologies in networked control systems," *Control Eng. Practice*, vol. 11, no. 10, pp. 1099–1111, Oct. 2003.
- [6] D. Hristu-Varsakelis and W. S. Levine, *Handbook of Networked and Embedded Control Systems*. Cambridge, MA: Birkhäuser, 2005.
- [7] Z. Mao and B. Jiang, "Fault identification and fault-tolerant control for a class of networked control systems," *Int. J. Innov. Comput., Inform., Control*, vol. 3, no. 5, pp. 1121–1130, 2007.
- [8] Y. Wang and Z. Sun, " H_∞ control of networked control system via LMI approach," *Int. J. Innovative Comput., Inform., Control*, vol. 3, no. 2, pp. 343–352, 2007.
- [9] D. Yue, Q. L. Han, and C. Peng, "State feedback controller design of networked control systems," *IEEE Trans. Circuits Syst. II*, vol. 51, no. 11, pp. 640–644, Nov. 2004.
- [10] D. Carnevale, A. R. Teel, and D. Nešić, "A Lyapunov proof of an improved maximum allowable transfer interval for networked control system," *IEEE Trans. Automat. Control*, vol. 52, no. 5, pp. 892–897, May 2007.
- [11] L. Xiao, A. Hassibi, and J. P. How, "Control with random communication delays via a discrete-time jump system approach," in *Proc. Amer. Control Conf.*, Chicago, IL, Jun. 2000, vol. 3, pp. 2199–2204.
- [12] P. Seiler and R. Sengupta, "An H_∞ approach to networked control," *IEEE Trans. Automat. Control*, vol. 50, no. 3, pp. 356–364, Mar. 2005.
- [13] L. Zhang, Y. Shi, T. Chen, and B. Huang, "A new method for stabilization of networked control systems with random delays," *IEEE Trans. Automat. Control*, vol. 50, no. 8, pp. 1177–1181, Aug. 2005.
- [14] F. Yang, Z. Wang, Y. S. Hung, and M. Gani, " H_∞ control for networked systems with random communication delays," *IEEE Trans. Automat. Control*, vol. 51, no. 3, pp. 511–518, Mar. 2006.
- [15] J. Xiong and J. Lam, "Stabilization of linear systems over networks with bounded packet loss," *Automatica*, vol. 43, no. 1, pp. 80–87, Jan. 2007.

- [16] J. Wu and T. Chen, "Design of networked control systems with packet dropouts," *IEEE Trans. Automat. Control*, vol. 52, no. 7, pp. 1314–1319, Jul. 2007.
- [17] D. Huang and S. K. Nguang, "State feedback control of uncertain networked control systems with random time-delays," *IEEE Trans. Automat. Control*, vol. 53, no. 3, pp. 829–834, Apr. 2008.
- [18] Y. Ji and H. J. Chizeck, "Controllability, stabilizability, and continuous-time Markovian jump linear quadratic control," *IEEE Trans. Automat. Control*, vol. 35, no. 7, pp. 777–788, Jul. 1990.
- [19] P. Shi and E.-K. Boukas, " H_∞ control for Markovian jumping linear systems with parametric uncertainties," *J. Optimiz. Theory and Applic.*, vol. 95, no. 1, pp. 75–99, 1997.
- [20] P. Shi, E.-K. Boukas, and R. K. Agarwal, "Control of Markovian jump discrete-time systems with norm bounded uncertainty and unknown delay," *IEEE Trans. Automat. Control*, vol. 44, no. 11, pp. 2139–2144, Nov. 1999.
- [21] O. L. V. Costa and R. P. Marques, "Robust H_2 -control for discrete-time Markovian jump linear systems," *Int. J. Control*, vol. 73, no. 1, pp. 11–21, Jan. 2000.
- [22] M. C. de Oliveira and J. C. Geromel, "Numerical comparison of output feedback design methods," in *Proc. American Control Conf.*, Albuquerque, NM, Jun. 1997, vol. 1, pp. 72–76.
- [23] L. Zhang, B. Huang, and J. Lam, " H_∞ model reduction of Markovian jump linear systems," *Syst. Control Lett.*, vol. 50, no. 2, pp. 103–118, Oct. 2003.

Coordinating Batch Production and Pricing of a Make-to-Stock Product

Liuxin Chen, Youyi Feng, and Jihong Ou

Abstract—Consider a make-to-stock product that is produced in batches and sold in individual units. The production process is stochastic with its mean time controllable in a fixed range; and the product is sold at either a high price with a low demand or a low price with a high demand. Coordinating the dynamic adjustment of the production rate and the sale price is crucial for maximizing the total discounted profit. We derive in this note that, the optimal control of the production rate follows a critical stock policy and the optimal pricing follows a price-switch threshold policy, with both associated with the finished goods inventory.

Index Terms—Batch production, critical stock policy, dynamic pricing, make-to-stock, optimal production control, price-switch threshold policy.

I. INTRODUCTION

Most manufacturing systems make products in batches so as to more efficiently utilize machinery and labor resources, especially for the make-to-stock products. In this note we consider a simple model of a batch-production, make-to-stock manufacturing system. The batch sizes are constant. The production process is stochastic with its mean time controllable in a fixed range. The product is sold at either a high price with a low demand or a low price with a high demand. The costs

Manuscript received February 18, 2008; revised February 19, 2008, August 24, 2008, December 21, 2008, and March 06, 2009. Current version published July 09, 2009. This work was supported by the Research Grants Council of the Hong Kong Special Administrative Region (Project CUHK4235/03E). Recommended by Associate Editor X. Xie.

L. Chen and Y. Feng are with the Department of Management Sciences, City University of Hong Kong, Kowloon, Hong Kong (e-mail: lindawuge@hotmail.com; yfeng@live.com).

J. Ou is with the Cheung Kong Graduate School of Business, Beijing, China (e-mail: jhou@ckgsb.edu.cn).

Digital Object Identifier 10.1109/TAC.2009.2020639