

Experimental comparison of power- and wave-based control of remote dynamic proxies for networked haptic cooperation

Zhi Li

*Department of Mechanical Engineering
University of Victoria
Victoria, BC, V8W 3P6 Canada
zhil@me.uvic.ca*

Daniela Constantinescu

*Department of Mechanical Engineering
University of Victoria
Victoria, BC, V8W 3P6 Canada
danielac@me.uvic.ca*

Abstract—This paper investigates through experiments the performance of two recent control architectures for networked haptic cooperation [10], [11]. The two architectures can render direct haptic interaction between networked users in addition to cooperative manipulation of virtual objects. This is because both architectures employ remote dynamic proxies to represent users at their networked peer sites. The remote dynamic proxies have second order dynamics and are controlled by the distant user whom they represent via virtual coupling (i.e., power-based) control or via wave-based control. The remote dynamic proxies render smooth motion of their respective user in the presence of update discontinuities caused by limited network transmission rates and by network delays. The experimental comparison investigates the performance of cooperative manipulation and of direct user-to-user contact for various constant network delays. The results illustrate that: (1) both power-based and wave-based control of remote dynamic proxies can maintain high position coherency between the distributed copies of the shared virtual object; (2) wave-based control of remote dynamic proxies renders the inertia of the shared virtual object and of the remote dynamic proxies more realistically than virtual coupling control; and (3) wave-based control of remote dynamic proxies maintains the networked haptic cooperation stable for longer constant network delays.

Index Terms—Networked haptic cooperation, remote dynamic proxy.

I. INTRODUCTION

Realistic force interaction among distant users is beneficial in applications like surgical training [12], telerehabilitation [18], and computer games. Depending on the application, users involved in networked haptic interaction may need: (1) to manipulate virtual objects together; and (2) to touch and feel each other directly. For example, during surgical teletraining with force feedback, the expert surgeon and the remote resident may need to perceive each other's interaction with the virtual organ on which they operate. During haptics-based telerehabilitation, the therapist may need to guide and feel the hand of the remote patient directly in order to gauge their physical abilities.

A. Prior Work

Prior research addressing networked haptic interaction has focused primarily on cooperative manipulation of a shared

virtual object (SVO). Both centralized (client-server) [6], [17] and distributed (peer-to-peer) [2], [4], [8], [7], [16], [17], [10], [11] control architectures have been investigated. Available studies have shown that peer-to-peer architectures can display larger contact stiffness [6] and can maintain higher position coherency between the copies of the SVOs [17] than client-server architectures. In existing distributed approaches [6], [16], the remote users interact via their local copies of the SVO. In turn, those local copies are connected via virtual coupling (i.e., power-based) control [5], time domain passivity-based control [15] and wave-based control [13]. The investigation in [16] has shown that: virtual coupling control is sensitive to network delay; time domain passivity-based control may not be able to prevent distracting oscillations; wave-based control may enforce poor coherency between the distributed copies of the SVO. Besides coordinating the distributed copies of the SVO through virtual coupling, the architecture in [6] provides the position and the velocity (i.e., a kinematic avatar) of the remote user at their peer site. That kinematic avatar increases the position coherency between the distributed copies of the SVO.

Initial research on haptic rendering of direct user-to-user interaction has offered massless proxies with first order dynamics [12]. Compared to purely kinematic proxies [19], [14], the motion of proxies with first order dynamics can be controlled better during collisions with fixed virtual objects or with other proxies. Their performance in networked haptic cooperation has not been investigated. Direct interaction between networked users has recently been enabled through remote dynamic proxies (RDPs) with second order dynamics [10], [11]. The RDPs are avatars of users in the virtual environment of their remote peer, and are coordinated via virtual coupling [10] or via wave-based control [11]. They increase the stability of the networked haptic interaction for constant network delays and for high contact stiffness.

Early work on perception and task performance in networked haptics has experimentally evaluated the impact of constant network delay on cooperation facilitated by client-server communications [1]. Perception has been assessed via contact stiffness and via users' physical intuition. The

experiments have revealed that users perceive increasingly larger force discontinuities and move ever slower as the network delay increases. Recent work has investigated the effect of constant network delay on users' perception of haptic cooperation with peer-to-peer communications [6], [16]. That research has shown that: longer network delays increase the user-perceived damping during cooperation with virtual coupling coordination [6]; and network delays result in smaller perceived force discontinuities when compensated via wave-based coordination instead of via virtual coupling [16].

B. Paper Objective and Structure

This paper presents an experimental comparison of two recent control architectures with RDPs for networked haptic cooperation [10], [11]. The RDPs enable direct haptic interaction between networked users in addition to cooperative manipulation of SVOs. The RDPs may be controlled by the users whom they represent via virtual coupling (i.e., power-based control) [10] or via wave-based control [11]. This work contrasts the benefits and limitations of the two types of RDP control. The investigation involves experimental cooperative manipulations and direct user-to-user interactions under various constant network delays. The results illustrate that: (1) both power-based and wave-based control of RDPs can maintain high position coherency between the distributed copies of the SVO; (2) wave-based control of RDPs renders the inertia of the SVO and of the RDPs more realistically; and (3) wave-based control of RDPs maintains the networked haptic cooperation stable for longer constant network delays. Due to the constant network delay assumption, these results apply to cooperation over a Local Area Network (LAN) or a high-speed Metropolitan Area Network (MAN) [6]. Internet-based cooperation will be a topic of future work.

In the remainder of the paper, Section II introduces the RDPs. Section III overviews their integration into the distributed control architectures with power-based (i.e., virtual coupling) and with wave-based coordination, respectively. Section IV presents the experimental results that validate the conclusions summarized in Section V.

II. THE REMOTE DYNAMIC PROXIES

This section briefly overviews RDPs for networked haptic interaction between two users. The extension to networked haptic cooperation among multiple users is a topic of future work.

RDPs have been introduced in [10] and [11] in order to allow networked users to touch and feel each other directly, in addition to permitting them to cooperatively manipulate SVOs. Direct force interactions between distant users are expected to benefit physical therapists assisting remote patients. As illustrated in Figure 1, a RDP is a user avatar in the virtual environment of a networked peer. For example, RDP_{12} is the RDP of Peer 1 in the virtual environment of Peer 2 in Figure 1. A RDP has the same mass and

damping as the haptic device of the user whom it represents. Its position and velocity are computed using physics-based simulation rather than being updated from network packets. RDPs are connected to their respective users via virtual coupling (Figure 1(a)) or via wave-based control (Figure 1(b)). This compliant connection allows users to perceive smoothly moving peers regardless of update discontinuities caused by network delays and by limited network transmission rates.

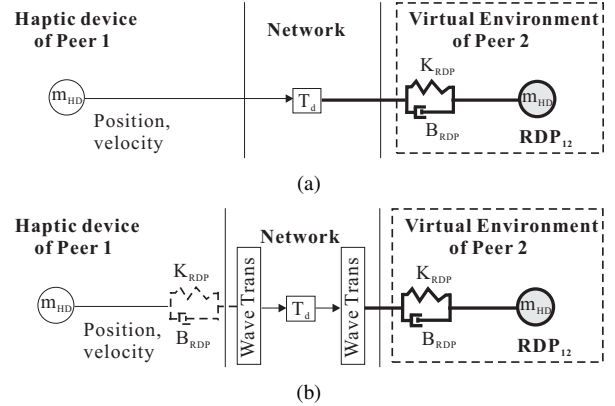

Fig. 1. RDPs coordinated via virtual coupling (Figure 1(a)) and via wave-based control (Figure 1(b)).

The additional computational effort involved in simulating the RDPs may limit the number of users simultaneously present in a shared virtual environment. However, this effort is minimal for the haptic cooperation between two users investigated in this paper.

III. DISTRIBUTED CONTROL ARCHITECTURES WITH REMOTE DYNAMIC PROXIES

The RDPs have been integrated into virtual coupling-based and into wave-based distributed control of networked haptic cooperation as shown in Figures 2(a) and 2(b), respectively. For simplicity and without loss of generality, the two haptic devices have been assumed to be similar. In Figure 2, notation is used as follows: T_d is the constant network delay; m_{HD} and b_{HD} are the mass and the damping of the haptic interfaces; m_{O_i} and b_{O_i} are the mass and the damping of Peer i 's copy of the SVO; K_{VC_i} and B_{VC_i} are the stiffness and the damping of the **local contact**, i.e. the contact between Peer i and its copy of the SVO; F_{VC_i} is the interaction force between Peer i and its copy of the SVO; $K_{VC_{ij}}$ and $B_{VC_{ij}}$ are the stiffness and the damping of the **remote contact**, i.e. the contact between Peer i 's RDP in Peer j 's virtual environment and Peer j 's copy of the SVO; $F_{VC_{ij}}$ is the interaction force between Peer i 's RDP and Peer j -th copy of the SVO; K_T and B_T are the stiffness and the damping of the virtual coupling coordinating the distributed copies of the SVO; F_{T_i} is the coordinating force applied on each copy of the SVO; K_{RDP} and B_{RDP} are the stiffness and the damping of the virtual coupler coordinating the RDPs to the users whose avatar

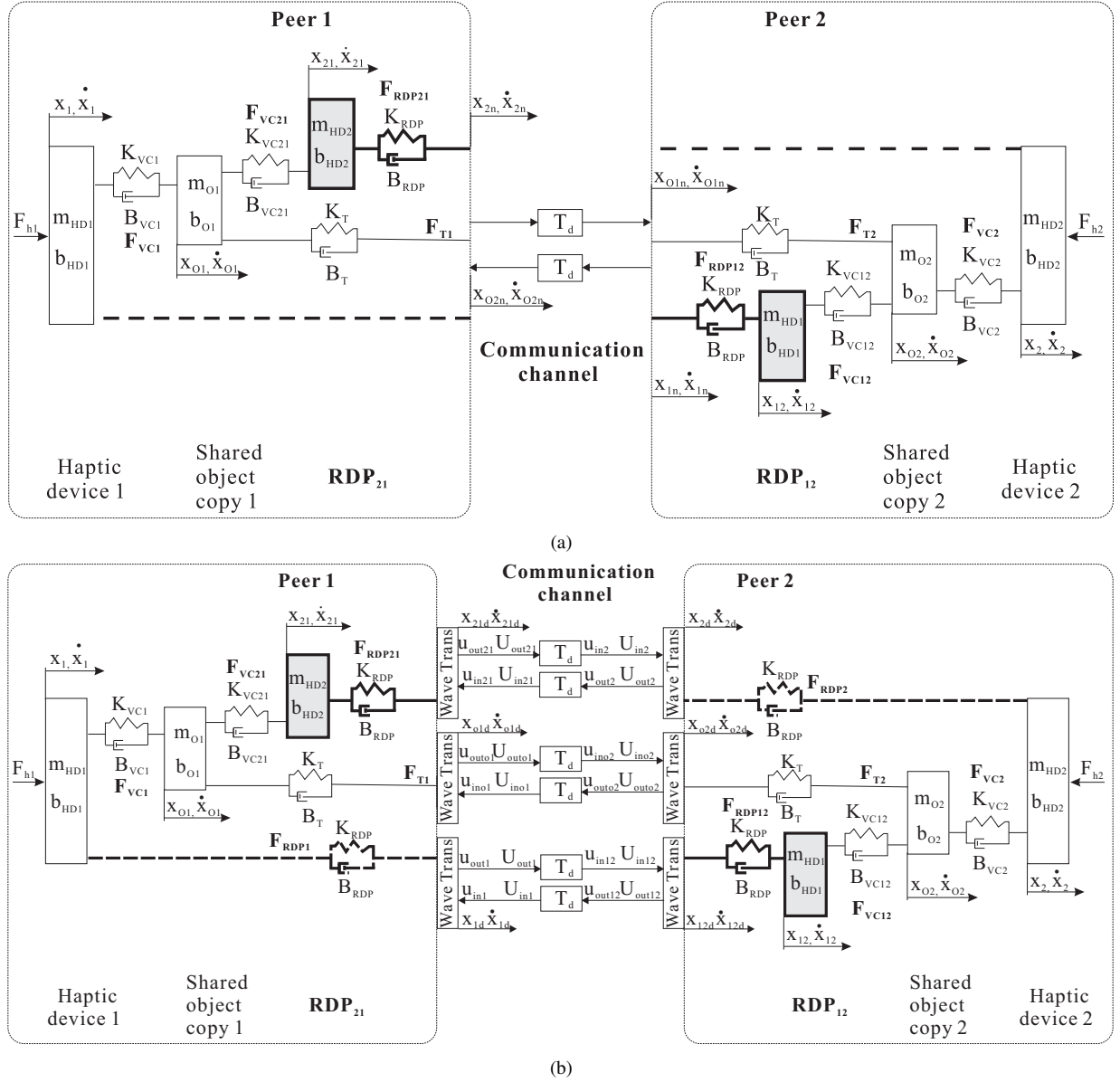

Fig. 2. Distributed control architectures with RDPs controlled via virtual coupling (Figure 2(a)) and via wave-based control (Figure 2(b)). The RDPs are shaded, and their connection to the corresponding haptic device is bolded.

they are; F_{RDPij} is the control force applied on the RDP of Peer i in the virtual environment of Peer j ; x_i and \dot{x}_i are the position and the velocity of the i -th haptic device; x_{O_i} and \dot{x}_{O_i} are the position and the velocity of Peer i 's copy of the SVO; x_{i_j} and \dot{x}_{i_j} are the position and the velocity of the RDP of Peer i in the virtual environment of Peer j ; lastly, F_{hi} is the force applied by the i -th user to their device. Since F_{VCi} and F_{VCij} represent unilateral contact forces, they are activated by collision detection. Furthermore, in Figure 2(a), x_{in} and \dot{x}_{in} are the position and the velocity commands sent by the i -th haptic device to their peer; x_{Oin} and \dot{x}_{Oin} are the

position and velocity commands sent by Peer i 's copy of the SVO to the peer user; u_{in} and u_{out} are wave signals; and U_{in} and U_{out} are wave integrals. In Figure 2(b), x_{id} and \dot{x}_{id} are the position and the velocity commands received by the i -th haptic device from their peer via wave signals; x_{Oid} and \dot{x}_{Oid} are the position and the velocity commands received by Peer i 's copy of the SVO from their peer's copy.

Note that, in the proposed architectures, the virtual environment of Peer i comprises: (1) a copy of the SVO jointly manipulated by the users; and (2) the RDP of Peer j , RDP_{ji} . The mass of the SVO m_O is equally divided between the

distributed copies, $m_{O_i} = \frac{m_O}{2}$, while its damping b_O is assigned to each copy, $b_{O_i} = b_O$. This distribution of the mass of the SVO among the local copies is typical in networked haptic cooperation between two users [6], [17]. However, it prescribes light local copies of the SVO and thus, leads to instability for cooperation among many users. Alternative approaches for distributing the mass of the SVO among many users will be investigated in upcoming work.

The dynamics of virtual coupling and of wave-based control of RDPs for networked haptic cooperation have been presented in detail in [10] and in [11], respectively. In the following section, the performance of the two controllers is contrasted for cooperative manipulation of a virtual cube, and for direct user-to-user interaction. The comparison evaluates: (1) the position coherency between the distributed copies of the virtual cube; (2) the accuracy of rendering the mass of the virtual cube and the mass of the RDO; and (3) the stability of the interaction for various constant network delays.

IV. EXPERIMENTS

A. Experimental Setup

The experimental networked haptic cooperation system employed in the experiments presented in this section is shown in Figure 3. The system comprises two FALCON NOVINT haptic devices connected to two personal computers. One computer runs Window XP on an Intel Core 2 Duo CPU at 2.67GHz with 2 GB RAM. The other computer runs Window Vista on an Intel Core 2 Duo CPU at 1.67GHz with 3 GB RAM. The haptic devices support point interaction in 3 degrees of freedom (DOF) virtual environments. The computers are located in the same laboratory, and can be screened from each other to prevent users from seeing their peer's display. Copies of a shared virtual environment comprising a rigid cube in a rigid enclosure are generated on each computer as C++ console applications. The computers communicate over the network via the UDP protocol. In the following experiments, the network environment is simulated via the Wide Area Network Emulator (WANem) [3]. The WANem runs on a separate personal computer. The position sensing rate and the force rendering rate of the haptic devices are 1KHz. The data transmission rate is 128Hz.

In all experiments, the haptic rendering rate is $T_c = 1/1024s$ and the network transmission rate is $T_n = 1/128s$. The mass of the virtual cube is $m_O = 0.25kg = 2m_{O1} = 2m_{O2}$, and the mass of the RDPs is $m_{HD} = 0.01kg$. Damping is incorporated neither in the RDPs nor in the virtual cube, i.e., $b_{O1} = b_{O2} = b_{HD} = 0Ns/m$. The various controller gains are: $K_{VC1} = K_{VC2} = 4000N/m$, $K_{VC21} = K_{VC12} = 10000N/m$, $K_T = 2000N/m$, $K_{RDP} = 1000N/m$, $B_{VC1} = B_{VC2} = B_{VC21} = B_{VC12} = 3Ns/m$, $B_T = 200Ns/m$, $B_{RDP} = 200Ns/m$.

Meaningful comparisons of successive interactions are enabled through controlled experiments. In other words, the

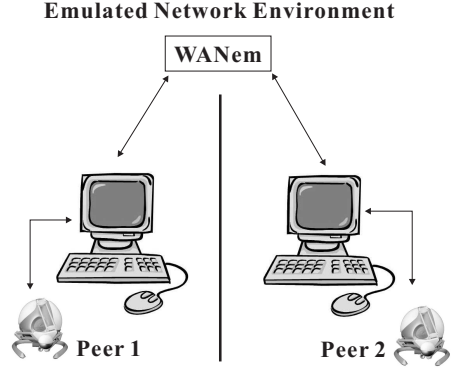

Fig. 3. The experimental networked haptic cooperation system.

peer users are substituted with controlled forces applied to the haptic devices through commands sent to motors via software. The controlled forces effectively eliminate the inherent peers' damping from the interaction. Since the haptic interfaces are impedance type devices, the controlled forces have no stabilizing effect on the networked interaction. The controlled experiments in this section have been validated via similar experiments with human users in [9].

B. Experiment I - Cooperative Manipulation

This section investigates the ability of virtual coupling and of wave-based control of RDPs: (1) to maintain position coherency between the copies of a shared virtual cube cooperatively manipulated by two peer users; and (2) to render the mass of the shared virtual cube and of the RDPs realistically. Figure 4 depicts the snapshot of the screen of Peer 1 at the beginning of this experiment. The two peers are initially at rest and in contact with the virtual cube. During the experiment, Peer 1 pushes the virtual cube and Peer 2 with a constant force $F_{h1} = 5N$, whereas Peer 2 remains passive. The rigid enclosure ensures the same initial conditions in successive experiments and limits the interaction to the x-axis.

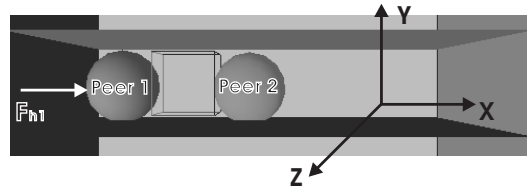

Fig. 4. Peer 1's initial screen in Experiment I (Cooperative Manipulation).

Figure 5 illustrates the experimental position coherency for three constant network delays: 10ms, 50ms, and 100ms. Note that virtual coupling and wave-based control of RDPs maintain similar position coherency between the local copies of the jointly manipulated cube. This is unlike in networked haptics without RDPs, where virtual coupling control has

been shown to maintain better position coherency than wave-based control [16].

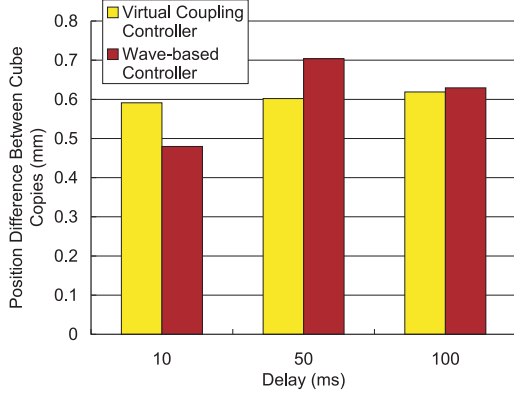

Fig. 5. Position coherency during cooperative manipulation rendered (1) via virtual coupling and (2) via wave-based control of RDPs.

Figures 6 and 7 depict the positions and forces recorded during cooperative manipulation under a constant network delay of $T_d = 50\text{ms}$, and rendered via virtual coupling and via wave-based control of RDPs, respectively. Note in these figures that users move the virtual cube much slower under virtual coupling control than under wave-based control of RDPs. Furthermore, users' position histories in Figure 6 are almost linear, confirming that virtual coupling control renders the network delay similarly to viscous damping [6]. Meanwhile, users' position histories in Figure 7 are parabolic, illustrating that wave-based control renders the mass of the shared virtual cube and of the RDPs realistically in the presence of constant network delays.

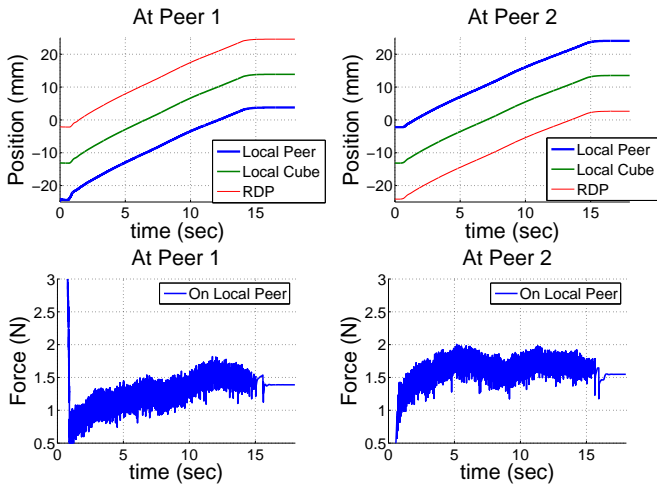

Fig. 6. Cooperative manipulation rendered via virtual coupling control of RDPs. $T_d = 50\text{ms}$.

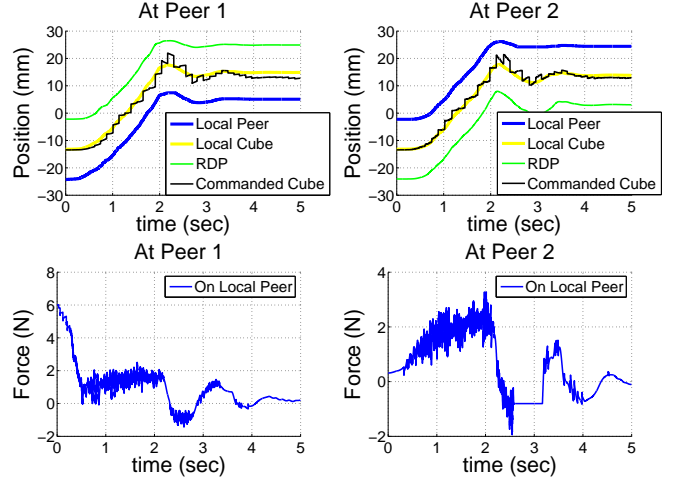

Fig. 7. Cooperative manipulation rendered via wave-based control of RDPs. $T_d = 50\text{ms}$.

C. Experiment II - Stability under Long Network Delay

This section validates through experiments that wave-based control of RDPs maintains the networked haptic interaction stable for larger constant network delays than their virtual coupling control. In particular, it presents the results obtained during cooperative manipulation (Figure 9) and during direct user-to-user interaction (Figure 10) under wave-based control of RDPs for a network delay $T_d = 400\text{ms}$. The joint manipulation and the direct user-to-user interaction become unstable when the network delay increases to $T_d = 200\text{ms}$ if the RDPs are coordinated via virtual coupling.

Figure 9 presents the experimental results for the cooperative manipulation depicted in Figure 4. Figure 8 shows the snapshot of the screen of Peer 1 at the beginning of the direct user-to-user interaction experiment. The two users are initially at rest and in contact with each other. During this experiment, Peer 1 pushes Peer 2 with a constant force $F_{h_1} = 5\text{N}$, whereas Peer 2 remains passive.

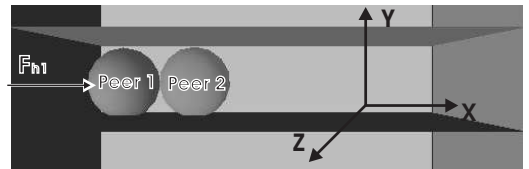

Fig. 8. Peer 1's initial screen in Experiment II (Direct User-to-User Interaction).

V. CONCLUSION

This paper has presented an experimental comparison of virtual coupling (i.e., power-based) [10] and wave-based [11] control of RDPs for networked haptic interaction. The RDPs render smooth motion of the distant users in the presence of

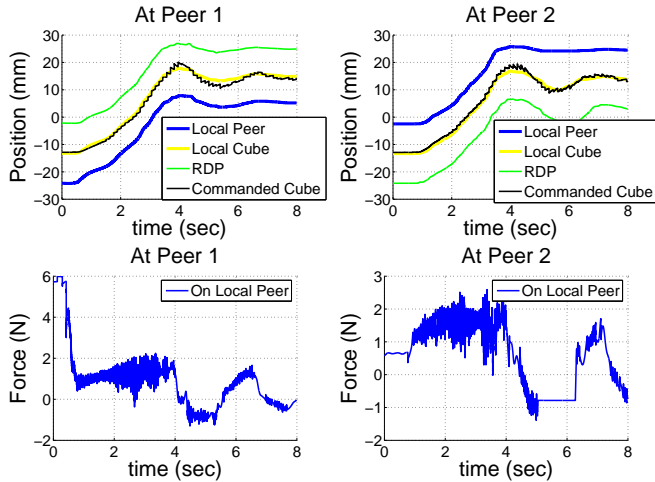

Fig. 9. Cooperative manipulation rendered via wave-based control of RDPs. $T_d = 400\text{ms}$.

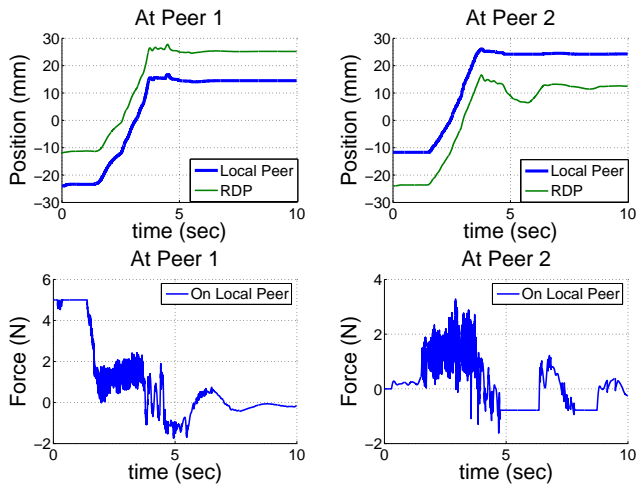

Fig. 10. Direct user-to-user interaction rendered via wave-based control of RDPs. $T_d = 400\text{ms}$.

update discontinuities caused by constant network delays and by limited network transmission rates. Hence, they support direct user-to-user interaction in addition to cooperative manipulation. The present experimental investigation of virtual coupling and of wave-based control of RDPs demonstrates that: (1) both virtual coupling and wave-based control can maintain high position coherency between the distributed copies of the SVO; (2) wave-based control renders the inertia of the SVO and of the RDPs more accurately; and (3) wave-based control of RDPs maintains the networked haptic cooperation stable for longer constant network delays.

Upcoming work will focus on: (1) the stability analysis of networked haptic interaction via RDPs in the presence of constant network delays; (2) the investigation of Internet-based haptic cooperation rendered via RDPs; and (3) the

integration of the RDPs into haptic cooperation among many users.

ACKNOWLEDGEMENT

This work has been supported by an NSERC Discovery Grant.

REFERENCES

- [1] M. Alhalabi, S. Horiguchi, and S. Kunifuji. An experimental study on the effects of Network delay in Cooperative Shared Haptic Virtual Environment. *Computers and Graphics*, 27(2):205–213, 2003.
- [2] P. Buttolo, R. Oboe, and B. Hannaford. Architectures for Shared Haptic Virtual Environments. *Computer & Graphics*, pages 1–10, 1997.
- [3] P. E. R. Centre. WANem 1.1 Wide Area Network Emulator User Guide. 1:1 – 15, 2007.
- [4] J. Cheong, S.-I. Niculescu, A. Annaswamy, and M. Srinivasan. Motion synchronization in virtual environments with shared haptics and large time delays. In *Eurohaptics 2005 & Symp Haptic Interf Virt Envir Teleop Syst*, volume 1, pages 277–282, Pisa, Italy, 2005.
- [5] J. Colgate and M. Stanley. Issues in the Haptic Display of Tool Use. In *IEEE/RSJ Int Conf Intell Robot Syst*, pages 140–145, Pittsburgh, PA, USA, 1995.
- [6] M. Fotoohi, S. Sirouspour, and D. Capson. Stability and Performance Analysis of Centralized and Distributed Multi-rate Control Architectures for Multi-user Haptic Interaction. *Int J Robot Res*, 26(9):977–994, 2007.
- [7] M. Glencross, C. Jay, J. Feasel, L. Kohli, M. Whitton, and R. Hubbard. Effective Cooperative Haptic Interaction over the Internet. In *Virt Real Conf, 2007. VR '07. IEEE*, volume 1, pages 115–122, Charlotte, North Carolina, USA, 2007.
- [8] J. Kim, H. Kim, B. Tay, M. Muniyandi, M. Srinivasan, J. Jordan, J. Mortensen, M. Oliveira, and M. Slater. Transatlantic Touch: A Study of Haptic Collaboration over Long Distance. *Presence*, 13(3):328–337, 2004.
- [9] Z. Li. Networked haptic cooperation with remote dynamic proxies. Master's thesis, University of Victoria, 2009.
- [10] Z. Li and D. Constantinescu. Networked Haptic Cooperation using Remote Dynamic Proxies. In *Int Conf Adv Comp-Human Interf*, volume 1, pages 243–248, Cancun, Mexico, 2009.
- [11] Z. Li and D. Constantinescu. Remote dynamic proxies for wave-based peer-to-peer haptic interaction. In *World Haptics Conference 2009*, volume 1, pages 553–558, Salt Lake City, UT, USA, 2009.
- [12] P. Mitra and G. Niemeyer. Dynamic Proxy Objects in Haptic Simulations. In *IEEE Conf Robot Autom Mechatronics*, volume 2, pages 1054–1059, 2004.
- [13] G. Niemeyer and J. E. Slotine. Stable Adaptive Teleoperation. *IEEE J. Oceanic Eng.*, 16(1):152–162, 1991.
- [14] D. Ruspini, K. Korolov, and O. Khatib. Haptic Interaction in Virtual Environments. In *IEEE/RSJ Int Conf Intell Robot Syst*, volume 1, pages 128–133, Genoble, France, 1997.
- [15] J.-H. Ryu and C. Preusche. Stable Bilateral Control of Teleoperators Under Time-varying Communication Delay: Time Domain Passivity Approach. In *IEEE Int Conf Robot Autom*, volume 1, pages 3508 – 3513, Roma, Italy, 2007.
- [16] G. Sankaranarayanan and B. Hannaford. Experimental comparison of internet haptic collaboration with time-delay compensation techniques. In *IEEE Int Conf Robot Autom*, volume 1, pages 206–211, Pasadena, California, USA, 2008.
- [17] G. Sankaranarayanan and B. Hannaford. Experimental Internet Haptic Collaboration using Virtual Coupling Scheme. In *IEEE Symp Haptic Interf Virt Envir Teleop Syst*, volume 1, pages 259–266, Waltham, Massachusetts, USA, 2008.
- [18] H. Sugarman, E. Dayan, A. Weisel-Eichler, and J. Tiran. The Jerusalem Telerehabilitation System, a New, Low-Cost, Haptic Rehabilitation Approach. *CyberPsychology & Behavior*, 9(2):178–182, 2006.
- [19] C. Zilles and J. Salisbury. A Constraint-based God Object Method for Haptic Display. In *IEEE/RSJ Int Conf Intell Robot Syst*, volume 3, pages 146–151, Pittsburgh, PA, USA, 1995.