

Hardware of a CAD System

■ Computer System

■ Mainframe Computer and Graphics Terminals

- Powerful
- Inconvenient
- High cost

■ Turn-key CAD System

- Dedicated computer systems for CAD applications, consisting of a super-mini computer and several design work stations.
- Following the "central control concept"
- Inconvenient and not powerful enough for complex 3D modeling.

■ Workstations & High-End Personal Computers

- Supporting multiple tasks
- Supporting network and file-sharing – convenient
- Low costs
- Present and trend

Input and Output Devices

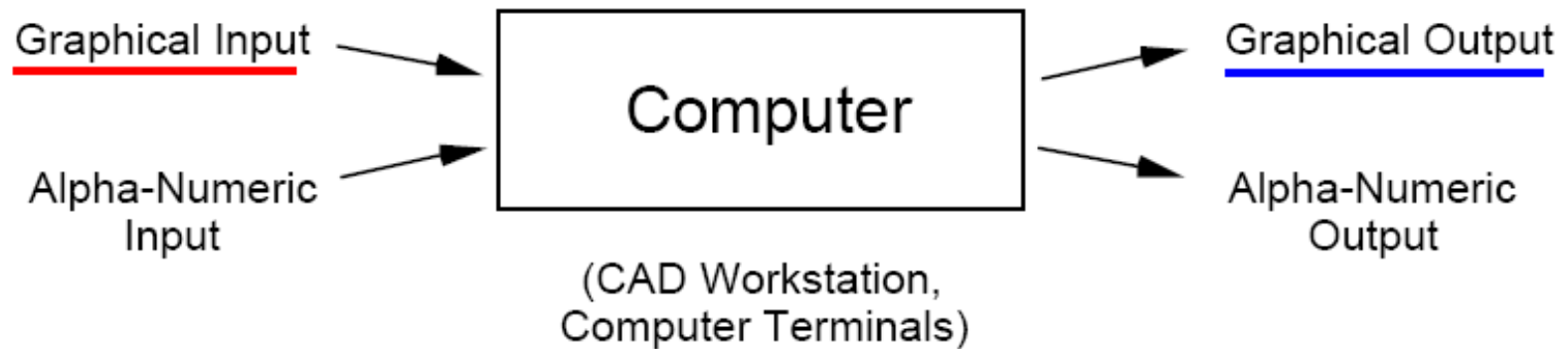

Graphical Output Devices:

(a) Two techniques:

Vector or Stroke Device
(example - pen plotter)

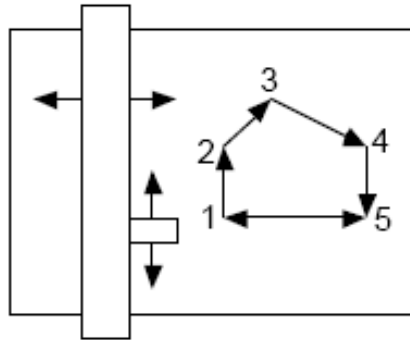

Instructions:

Pen up; X_4, Y_4 ;
 X_1, Y_1 ; X_5, Y_5 ;
Pen down; X_1, Y_1 ;
 X_2, Y_2 ; Pen up;
 X_3, Y_3

Raster Scan Device
(example - dot matrix printer, laser printer)

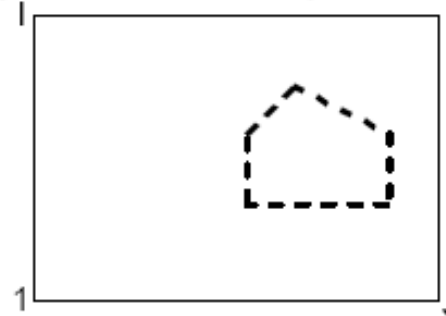

Use an array $A(I, J)$

where each element is
"0" or "1"

0 – blank
1 – dot

Graphical Output Devices:

Advantages

Vector

- (1) Good Resolution
 - (a) straight lines
 - (b) smooth curves
- (2) Requiring limited memory and few instructions

Raster

- (1) Speed independent of image
- (2) Difficult to do halftones shading Used to be

Disadvantages

- (1) Slow for complex images - flicker on CRT
- (2) Shading difficult and slow

- (1) Limited resolution Used to be
- (2) Requiring large memory for array storage

Graphical Output Devices:

(b) CRT (Cathode Ray Tube) - A Vector Device

The electron beam, which is deflected electrostatically or magnetically, causes phosphor coating to glow. Persistence depends on coating material (10-60 usec). The display is refreshed 30~60 times/sec. above the fusion frequency of the human eyes (23 times/sec).

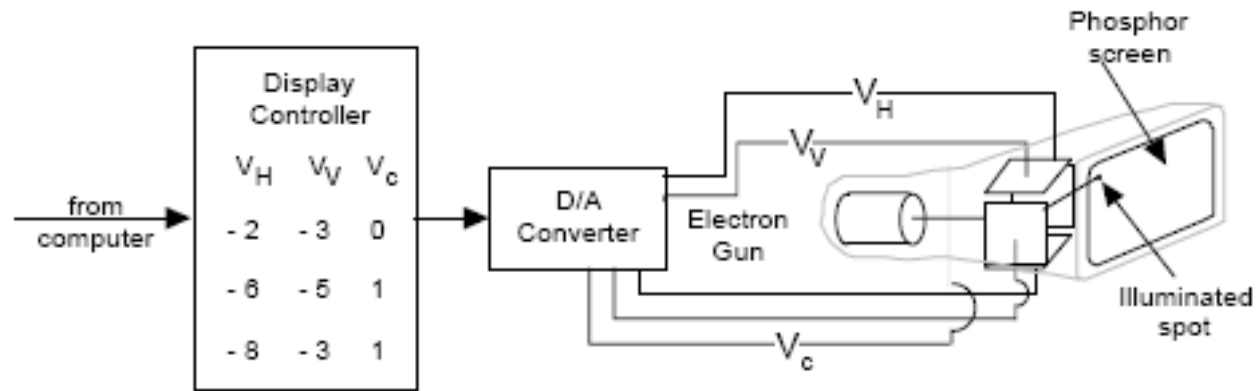

V_H – Horizontal Voltage $V_C = 0$ Beam off
 V_V – Vertical Voltage $V_C = 1$ Beam on

$$\text{Line intensity} \approx \frac{\text{time}}{\text{Length}} = \frac{1}{V} \text{ needs to be constant.}$$

Graphical Output Devices:

(c) Raster Device (Television Monitor)

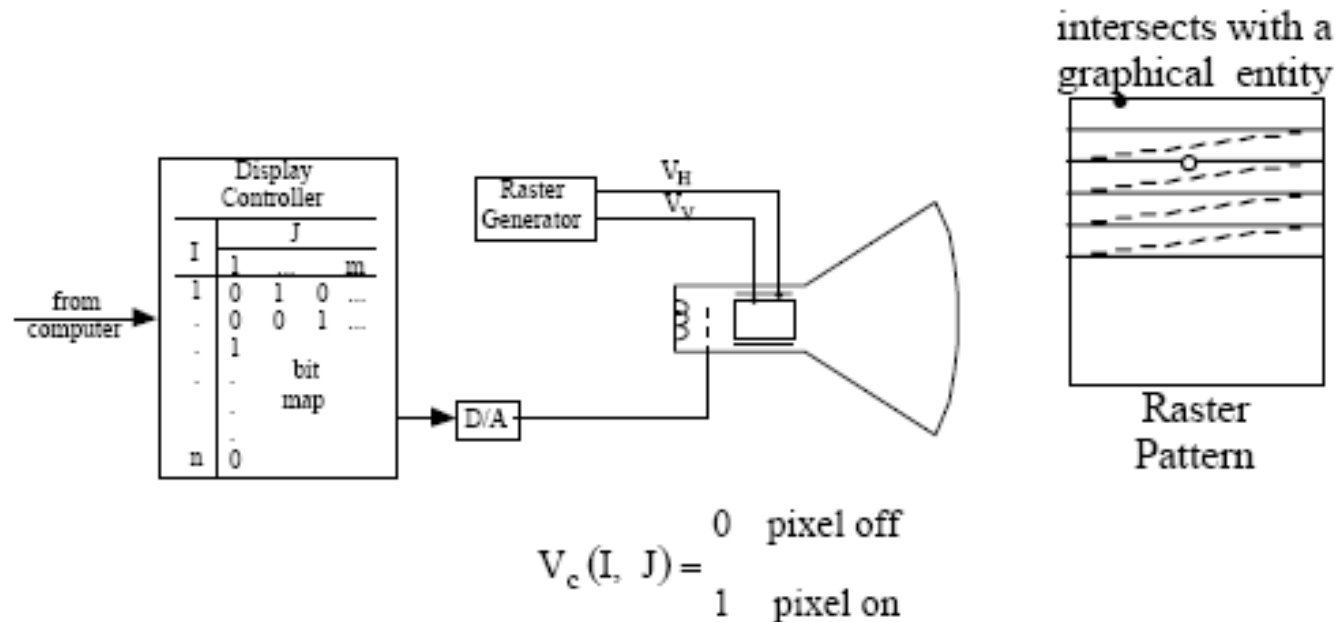

The resolution of the display is determined by the size of the screen pixel. This size is limited by the beam resolution (~ 0.01 u) and display memory.

An example: a 13-inch screen (8 inch x 10 inch),
 100 x 100 pixels/in² for a monochrome monitor,
 1 bit/pixel (8 bits for color or multiple gray levels)
 80 in² x 10,000 pixels/in² = 800,000 bits.

Two Raster Display Devices (CRT and LCD)

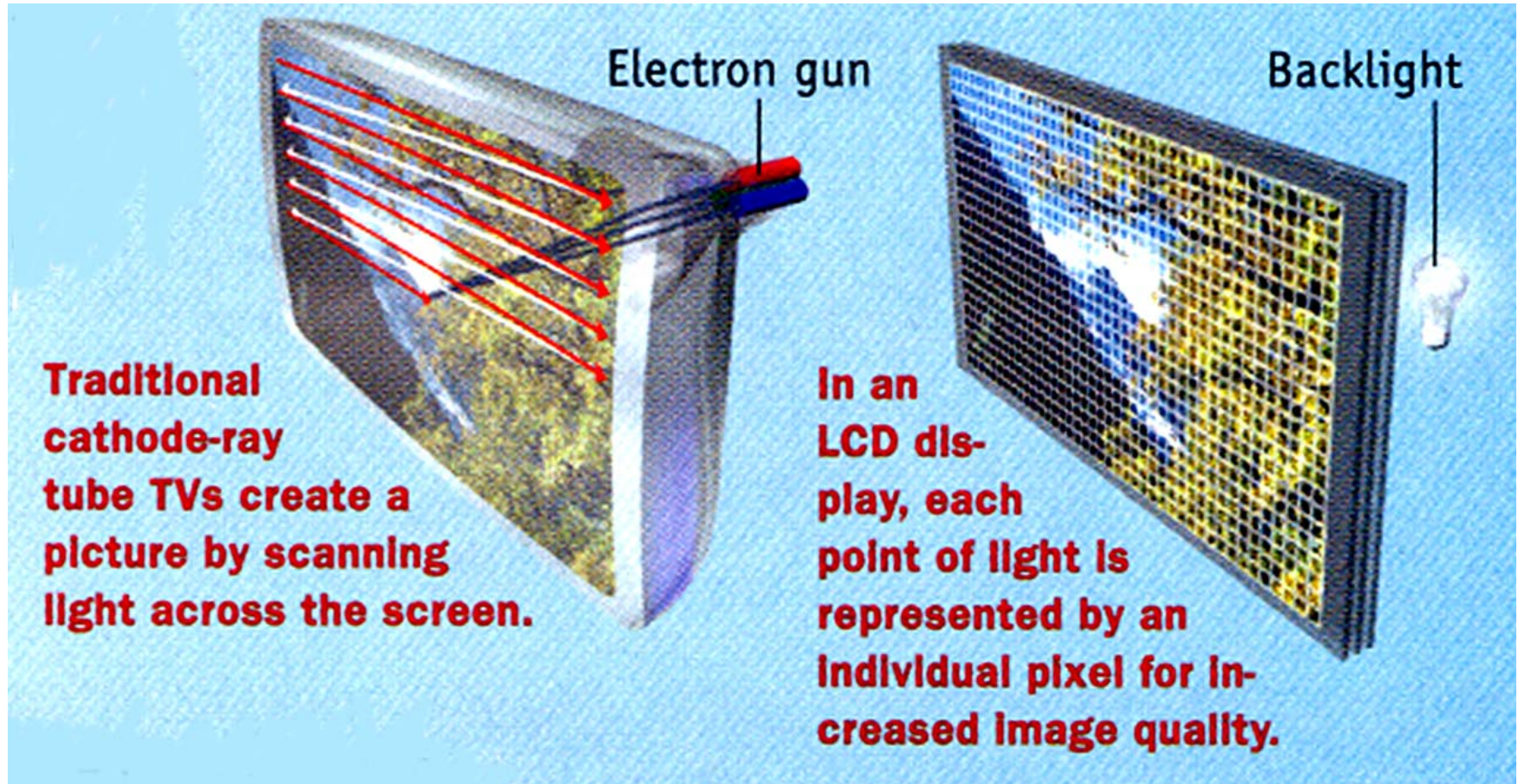

Graphics Card Selection

- Graphics card is as important as the CPU, RAM and hard drive for CAD, video, or graphics applications;
- The default graphics cards (GPU) listed by the computer manufacturer is mainly for regular business applications or video gaming, and is not appropriate for heavy graphics usage;
- Low-cost (under \$200) graphics cards or cards from unknown manufacture do not provide full **OpenGL** support that is required by CAD or graphics applications, affecting the performance and stability of the CAD and graphics application;
- CAD software vendors normally provide a **constantly updated** list of tested graphics cards and drivers.

Flat Panel Display (FPD) Technology

- LCD (Liquid-Crystal Display)
- Plasma Display
- DLP™ (Digital Light Processing™)
- Organic LED or OLED (Organic Light-emitting Diode)

Notes:

Plasma will outperform LCD by providing lots of dark and better contrast, but LCD outperforms plasma in brightness and color.

Cost of Plasma for larger size screen is lower, but it suffers from burn-in.

DLP shows its advantage for very large projection screens.

OLED represents future FPD technology.

Future Display Technologies – 3D Display

Gas-Plasma Display

Plasma display employs neon and xenon gases which are trapped between two thin layers of glass to create a digital image.

A small electric pulse is applied to each pixel to excite the gases to produce the color information and light.

These rare gases actually have a life and fade over time. The life of these phosphors is around 25,000 to 30,000 hours (not replaceable).



LCD (Liquid-Crystal Display)

- A matrix of thin-film transistors (TFTs) supplies voltage to liquid crystal-filled cells sandwiched between two sheets of glass.
- A trio of **red**, **green**, and **blue** cells make up one pixel.
- When hit with an electrical charge, the crystals "untwist" to an exact degree to filter light generated by
 - fluorescent or LED array backlight behind the screen (for flat-panel LCDs)
 - LCD has an expected life between 50,000 and 75,000 hours, as long as the backlight (often replaceable)
 - (first appeared in calculators in 1970s reflected light from back mirror)

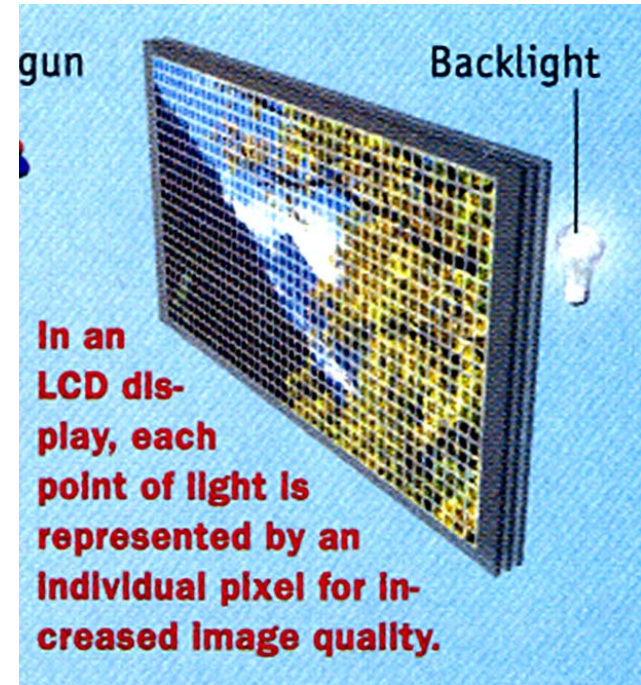

DLP™ (Digital Light Processing™)

- A semiconductor-based display, from Texas Instruments (1993)
- A panel of micromirrors are mounted on tiny hinges that enable them to tilt either toward or away from the light source in a DLP™ projection system (ON/OFF) - creating a light or dark pixel on the projection surface.
- The white light generated by the lamp in a DLP projection system passes through a color wheel as it travels to the surface of the DMD panel - **1-chip system**
- 3-chip DLP™ projection system has three light sources (RGB) and no color wheel.

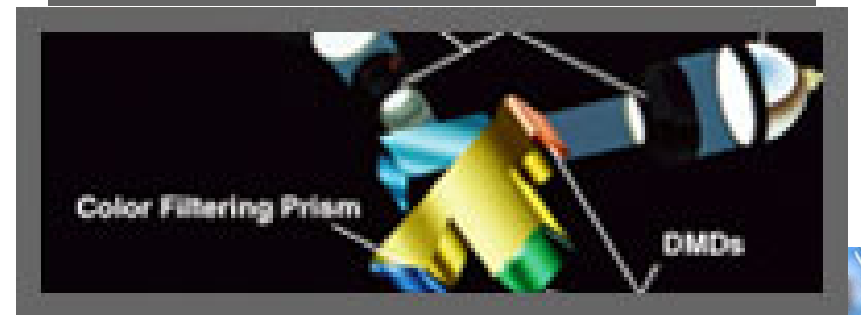
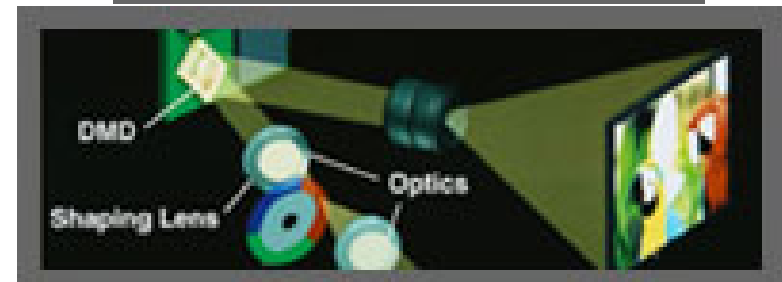
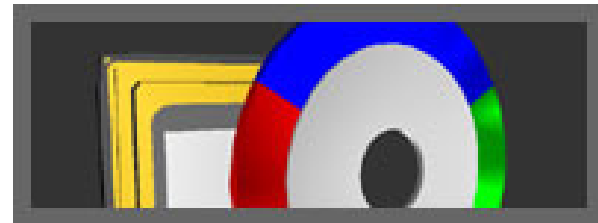

Light Valve Display

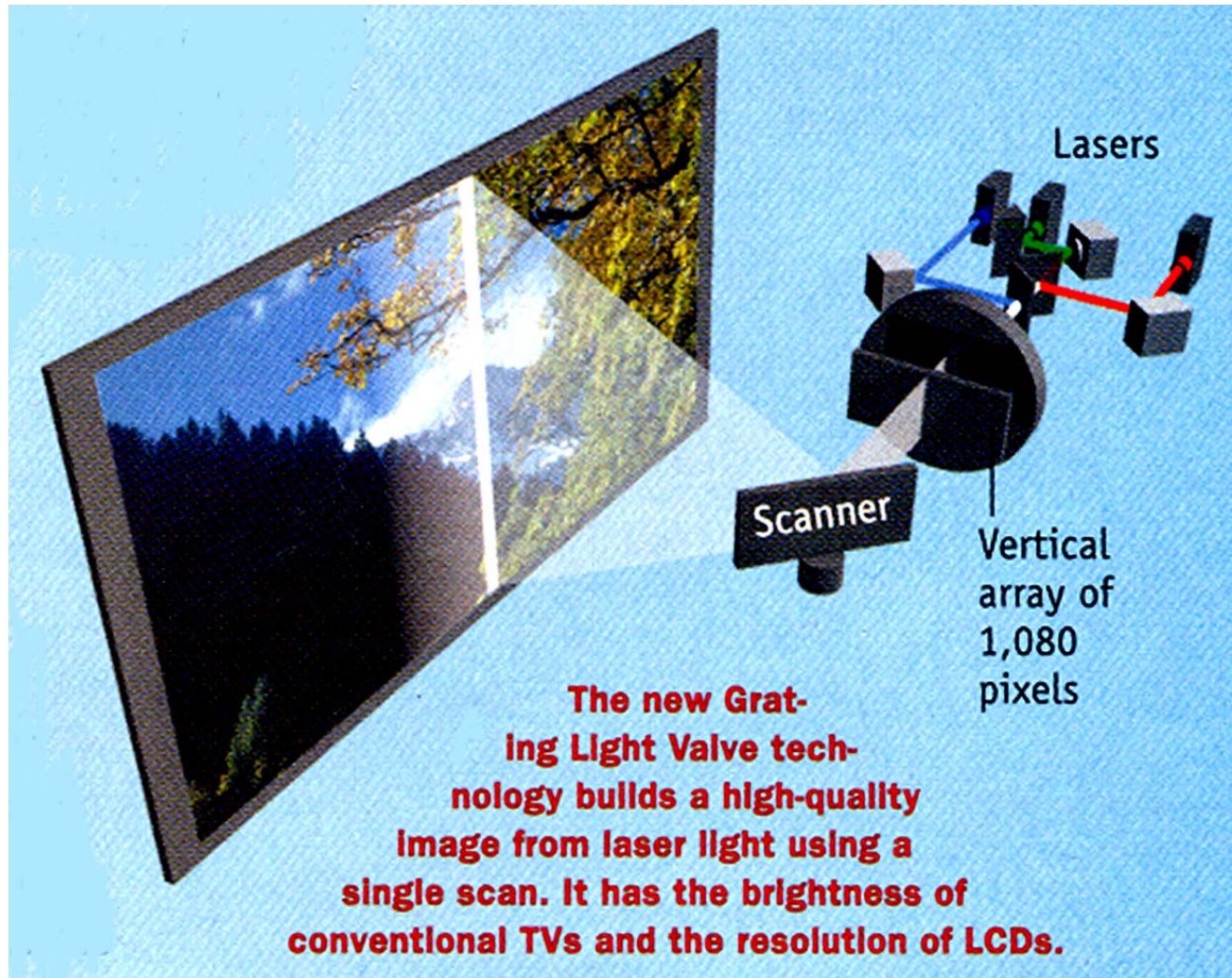

Organic Light-emitting Diode (OLED),

- OLED, also Light Emitting Polymer (LEP)
- The whole display can be built on one sheet of glass or plastic with a light emitting layer (rigid or flexible)
- The light emitting layer contains a polymer substance on which a layer of organic compounds are deposited/printed.
- It provides better performance at lower costs and use much less power.
- It displays full-color, video-rate imagery with much faster response times, wider viewing angles, and brighter, more saturated colors.



Key Technical Terms

■ Traditional

- **Refresh Rate** of CRTs is refers to how often the screen is redrawn per second. With low refresh rates you can get screen flicker and eye strain. Aim for a rate of 75 Hz for a monitor up to 17 inches in size and 85 Hz for any larger monitor.
- LCDs are basically flicker free so refresh rates are not as important.
- **Dot Pitch** is the distance in millimeters between phosphors of the same color. The smaller the dot pitch, the sharper the image. Opt for a dot pitch of 0.26 mm or smaller (usually quote horizontal dot pitch).

■ New

- **Brightness**: LCD monitors have several backlights that provide illumination. Brightness is measured in units called nits. The majority of LCDs produce 150-200 nits which is fine for most users. The backlights in a LCD are good for 10 to 50 thousand hours of operation.
- **Native Resolution** (Display Capability of the Hardware)
- **Dynamic Contrast Ratio** (and True Contrast Ratio)
- **Response Time** (Better LCD TVs operate at 120 Hz refresh rate for fast moving objects)

Blu-ray Disc physical specifications were finished in 2004 (1920x1080, 25-50GB)

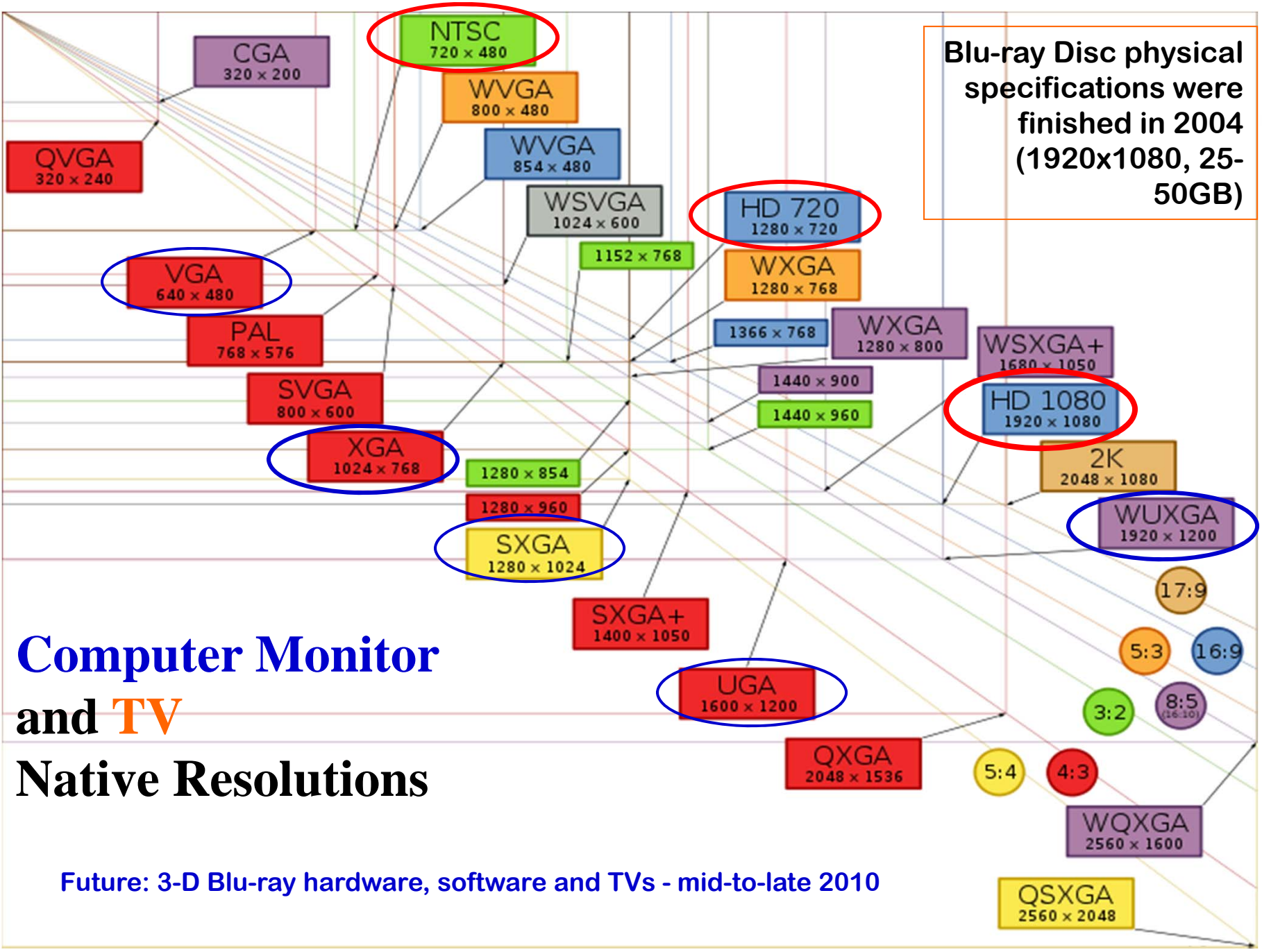

Computer Monitor and TV Native Resolutions

Future: 3-D Blu-ray hardware, software and TVs - mid-to-late 2010

Advanced Output: 3D and Virtual Reality

Virtual Reality & Factory Design

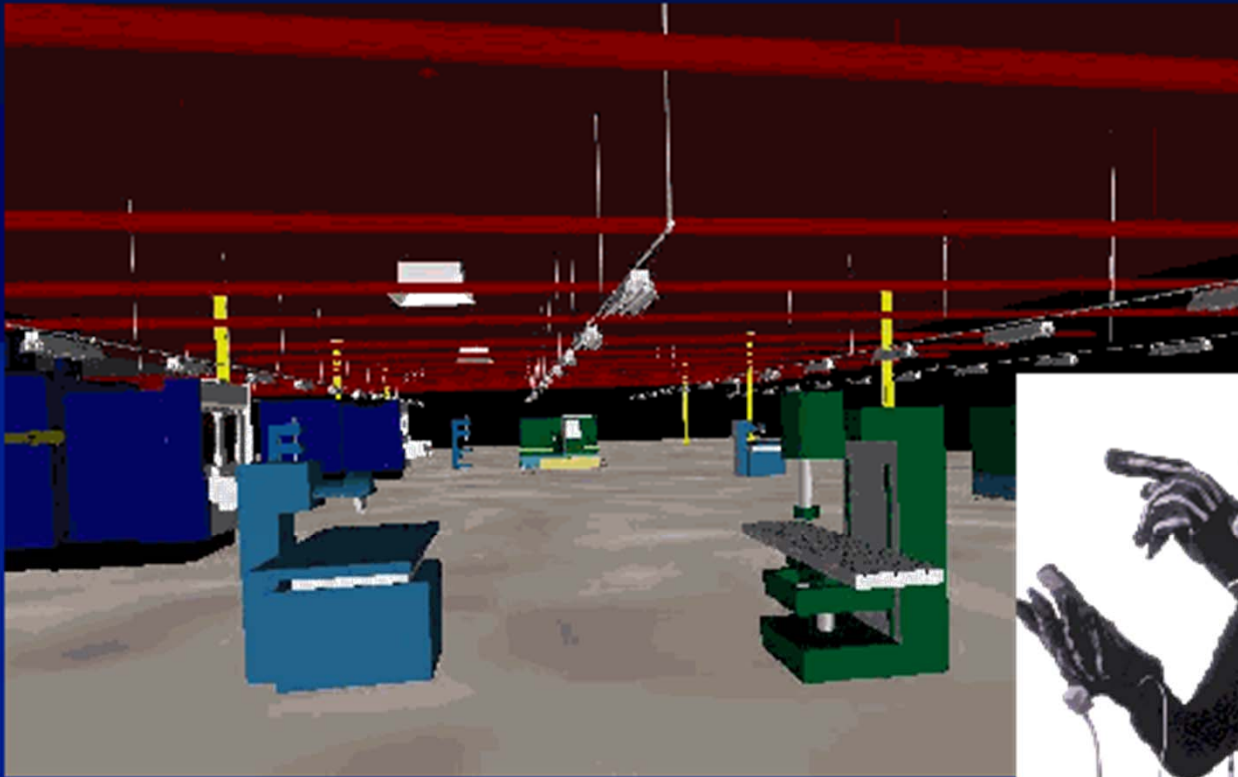

Virtual Reality: 3D CAVE

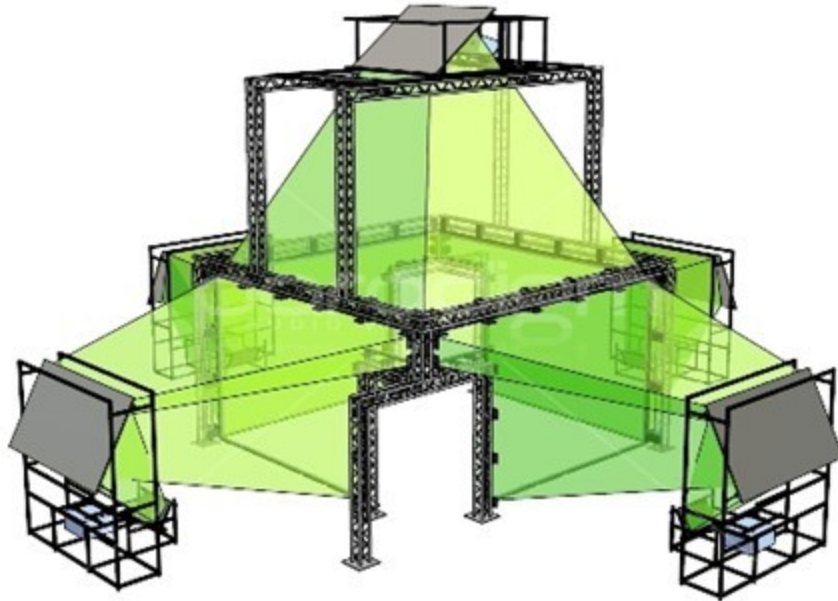

Stereoscopic Technology (3D Display)

Common 3D display technology for projecting stereoscopic image pairs to the viewer include:

- Anaglyphic 3D (with passive red-cyan glasses)
- Polarization 3D (with passive polarized glasses)
- Alternate-frame sequencing (with active shutter glasses/headgear)
- Autostereoscopic displays (without glasses/headgear)

Anaglyphic 3D

Anaglyph images are used to provide a stereoscopic 3D effect, when viewed with 2 color glasses (each lens a chromatically opposite color, usually red and cyan). Images are made up of two color layers, superimposed, but offset with respect to each other to produce a depth effect.

Colour rendering is not very accurate with this method.



Anaglyphic 3D

- A pair of eyeglasses with two filters of the same colors, once used on the cameras (or now simulated by image processing software manipulations) is worn by the viewer. In the case above, the red lens over the left eye allows only the red part of the anaglyph image through to that eye, while the cyan (blue/green) lens over the right eye allows only the blue and green parts of the image through to that eye. Portions of the image that are red will appear dark through the cyan filter, while portions of colors composed only of green and blue will appear dark through the red filter. Each eye therefore sees only the perspective it is supposed to see.



Polarization 3D

Polarized 3D glasses create the illusion of three-dimensional images by restricting the light that reaches each eye.

Light reflected from a motion picture screen tends to lose a bit of its polarization, but this problem is eliminated if a silver screen or aluminized screen is used.

- **A pair of aligned DLP projectors, some polarizing filters, a silver screen, and a computer with a dual-head graphics card can be used to form system for displaying stereoscopic 3D data simultaneously to a group of people wearing polarized glasses.**
- **In the case of RealD a circularly polarizing liquid crystal filter which can switch polarity many times per second is placed on front of the projector lens. Only one projector is needed, as the left and right eye images are displayed alternately.**
- **Polarized images can be obtained also on TVs with the use of a polarized screen.**

Polarization

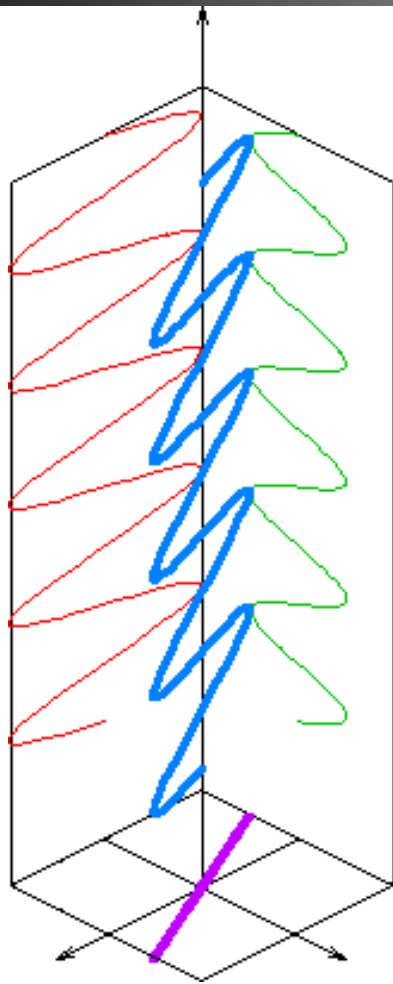

Linear

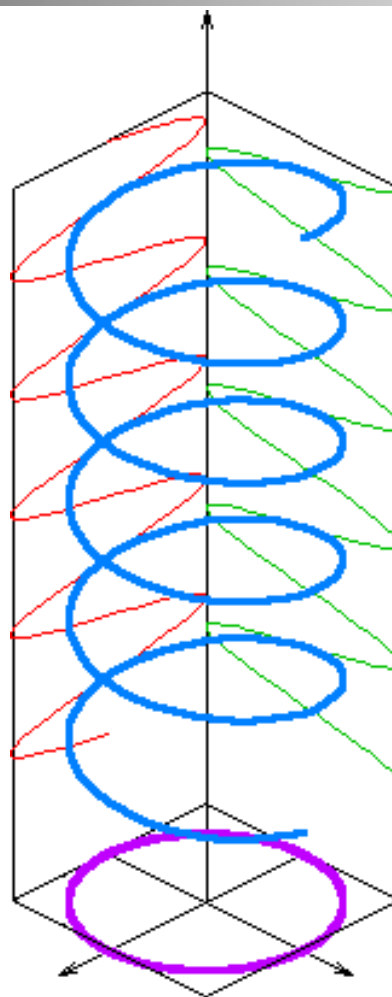

Circular

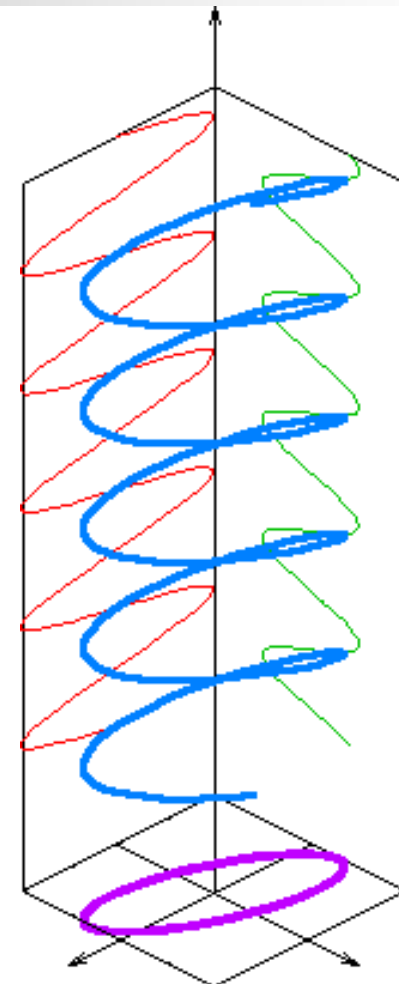

Elliptical

Alternate-Frame Sequencing (Eclipse Method)

- With the eclipse method, a mechanical shutter blocks light from each appropriate eye when the converse eye's image is projected on the screen. The projector alternates between left and right images, and opens and closes the shutters in the glasses or viewer in synchronization with the images on the screen.
- A variation on the eclipse method is used in LCD shutter glasses. Glasses containing liquid crystal that will let light through in synchronization with the images on the computer display or TV, using the concept of alternate-frame sequencing.

Autostereoscopic displays (without glasses/headgear)

- **Lenticular screens.**

Both images are projected onto a high-gain, corrugated screen which reflects light at acute angles. In order to see the stereoscopic image, the viewer must sit within a very narrow angle that is nearly perpendicular to the screen, limiting the size of the audience.

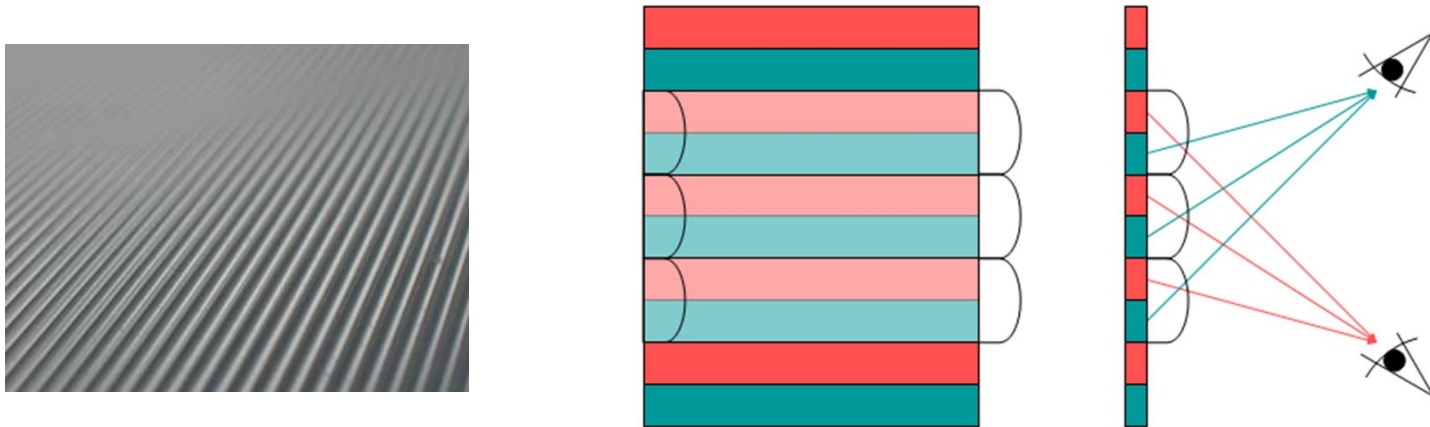

Autostereoscopic displays (without glasses/headgear)

■ Parallax Barrier

Placed in front of the normal LCD, it consists of a layer of material with a series of precision slits, allowing each eye to see a different set of pixels, so creating a sense of depth through parallax. A disadvantage of the technology is that the viewer must be positioned in a well defined spot to experience the 3D effect.

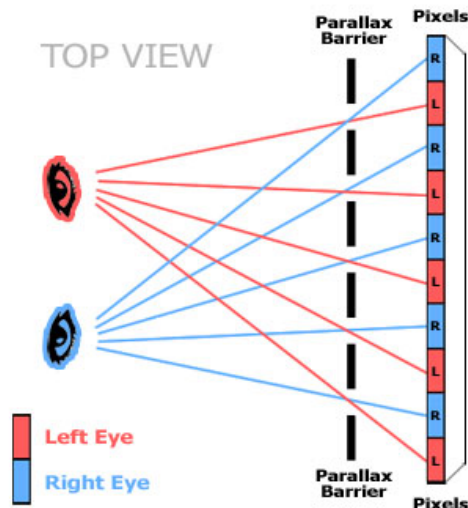

Blue Nintendo 3DS



Graphical Input Devices:

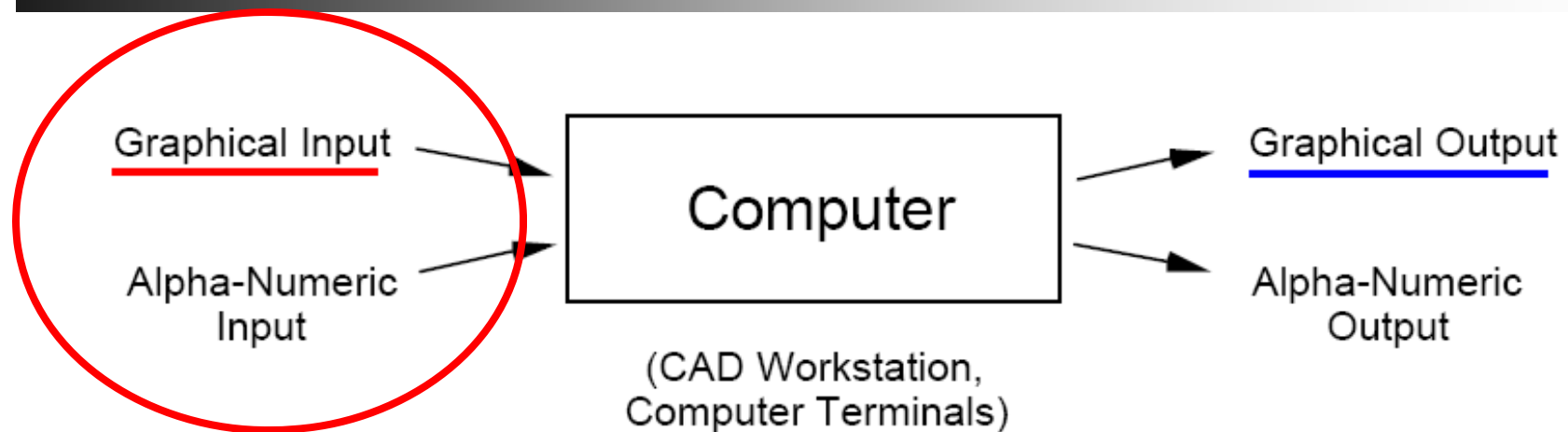

a) Keyboard

- Alphanumeric characters
- Graphical input by arrow keys

Pressing key sends an ASCII code to the computer. The software translates the ASCII code into a change in the cursor position. Return key enters location.

Graphical Input Devices:



b) Tablet

- Grid board

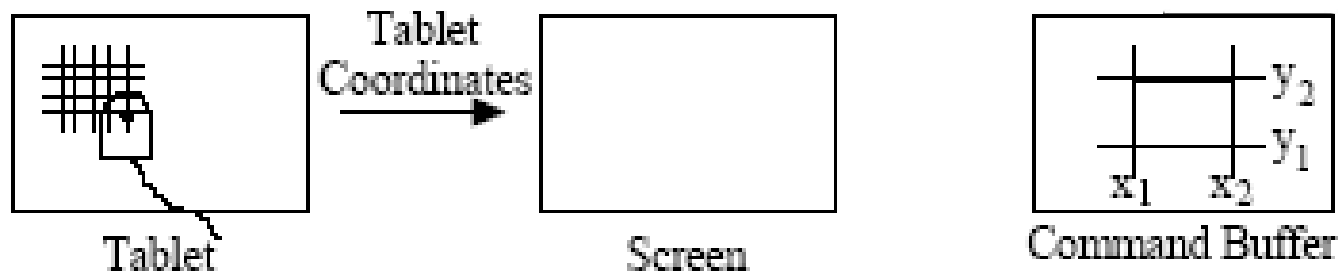

The embedded grid of wires in the tablet senses the electric field produced by the puck/pen and provides the software with puck/pen position. It can be used for

- updating the graphic cursor position
- digitizing a drawing on paper
- entering a system command

If $x_1 < x < x_2$ and $y_1 < y < y_2$, execute command "xxx"

Graphical Input Devices:

c) Mouse

- Mechanical Mouse (and Joystick)

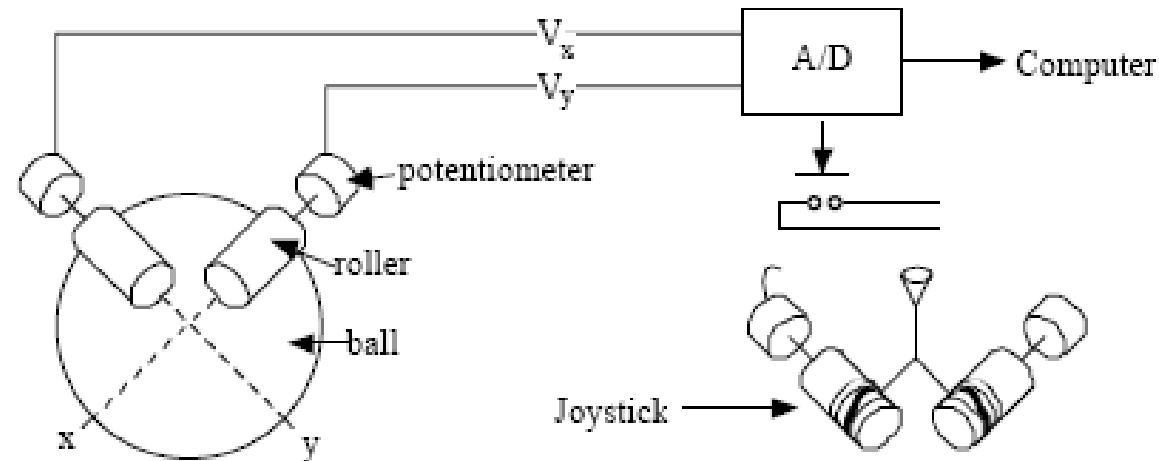

As the ball rolls on surface, rollers and potentiometers monitor changes in x, y coord. Button records position.

- Optical Mouse

LED illumination and grid interpreter

- Wireless Mouse

Infrared system and Bluetooth system: mouse (emitter) and USB connected receiver.

Graphical Input Devices:

d) Light Pen

The photomultiplier records the passage of the electron beam. Time lapse from the start of Raster determines the pen location.

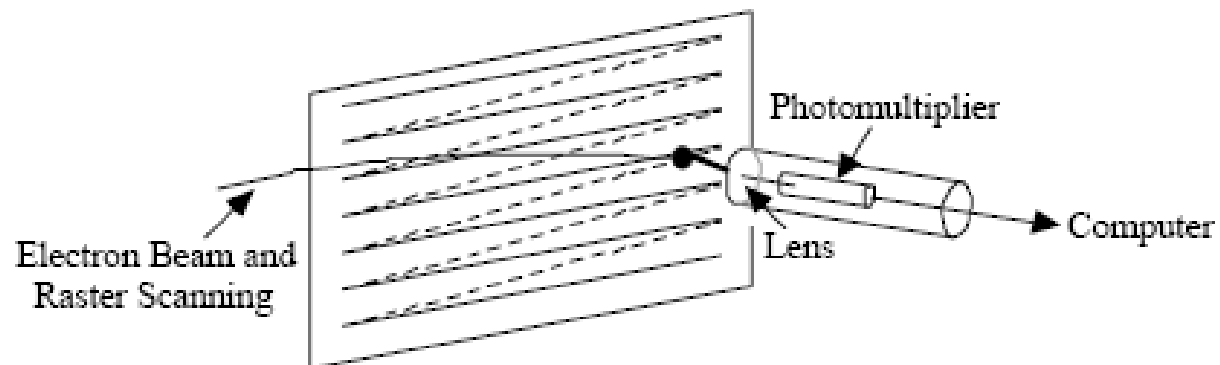

Graphical Input Devices:

(f) Valuator

For CAD and Simulation Workstations

- Light sensor based
 - two sensors on each top corner of the “pad” with a special/regular pen.

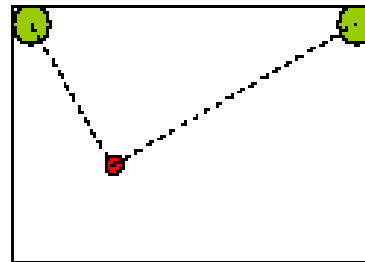
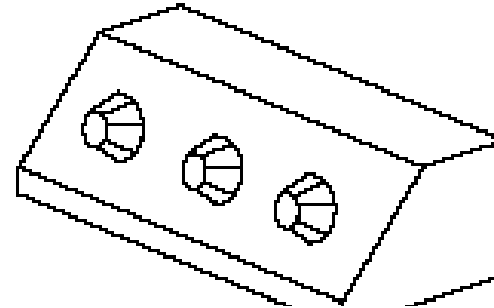

For wireless pen input, and electronic whiteboard



3D Mouse

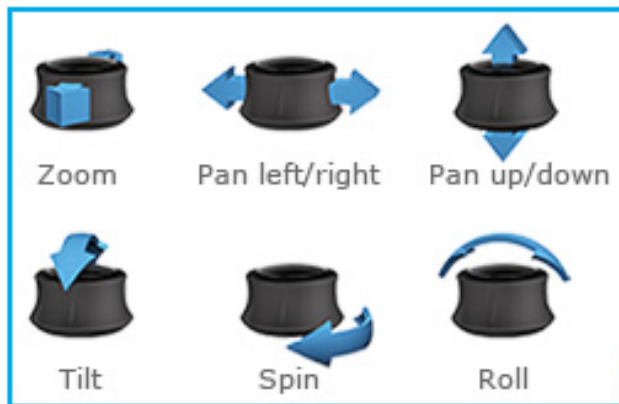

Graphical Input Devices: Touch Screen

Touch Sensors

- Arrays of beams and detectors (old)

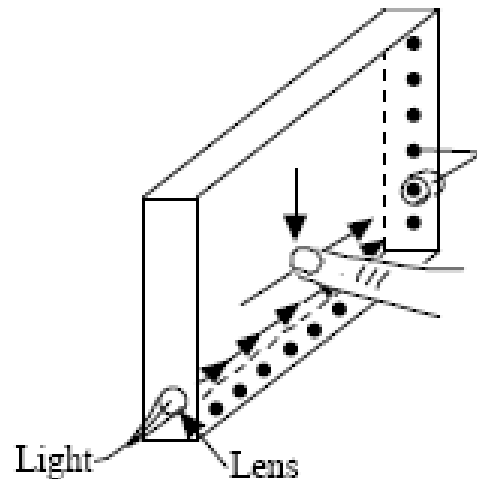

Arrays of infrared light sources and array of detectors are used to generate invisible light grids. A finger interrupts two light beams and provides x and y coordinates.

Graphical Input Devices: Touch Screen

- **Resistive:**

A resistive touchscreen panel is composed of several layers, the most important of which are two thin, electrically conductive layers separated by a narrow gap. When an object, such as a finger, presses down on a point on the panel's outer surface the two metallic layers become connected at that point. This causes a change in the electrical current, which is registered as a touch event and sent to the controller for processing.

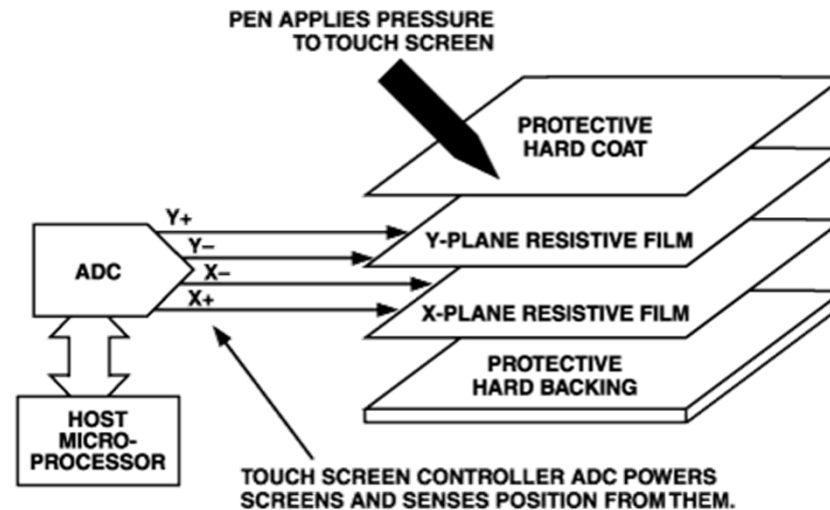

Graphical Input Devices: Touch Screen

- **Capacitive**

A capacitive touchscreen panel is one which consists of an insulator such as glass, coated with a transparent conductor such as indium tin oxide (ITO). As the human body is also a conductor, touching the surface of the screen results in a distortion of the screen's electrostatic field, measurable as a change in capacitance. Different technologies may be used to determine the location of the touch. The location is then sent to the controller for processing.

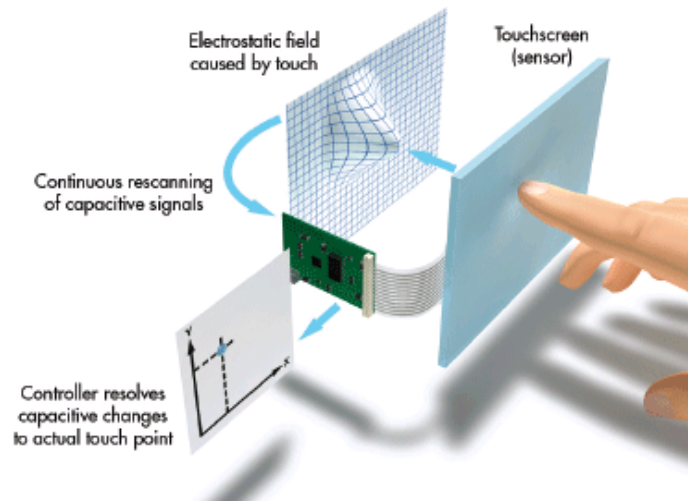

3D Range Data Acquisition and Its Applications

- **2D Image:** (for each pixel: X and Y coordinates and light intensity). The intensity could be gray (8 bits: 0 – 255) or color RGB (24 bits).
- **3D Range Image/Data from Range Sensing Devices and 3D Camera** – data points defined by their X, Y, and Z coordinates (cloud point data) – **added Depth.**
 - ***Mechanical probe (measurement and scanning)***
 - ***Laser scanning***
 - ***Triangulation-based*** range sensing devices
 - ***Time-of-flight based*** range sensing devices
 - ***Machine vision based CAD model generation for:***
 - reverse engineering
 - machine vision and intelligent robot
 - vehicle size measurement and traffic monitoring
 - scanning of 3D object, human body, and art work

Generation of CAD Model with Free-form Shape Automotive Design Example



Architecture
Design & Scaled
Clay Model



Automotive Design and CAD Model Generation

Scanning of Clay Model to Obtain Surface Data

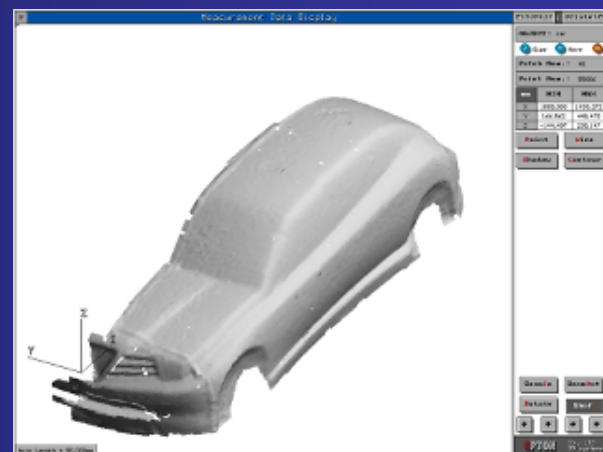
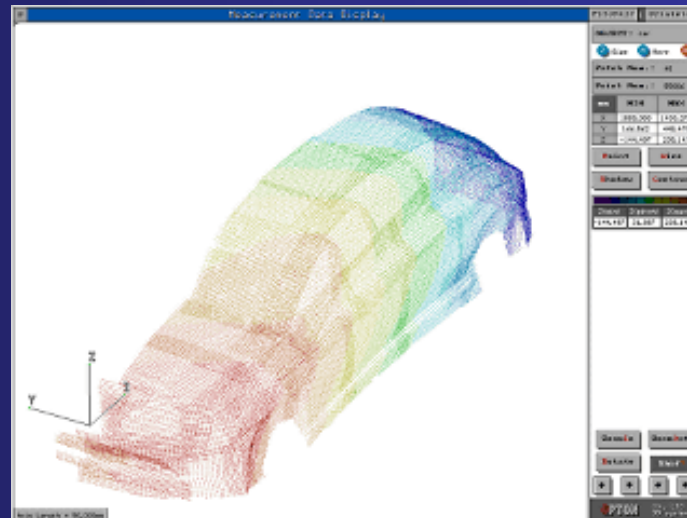

Full Size Foam Model Machined Using a 5-Axis CNC Mill from 3D CAD Model

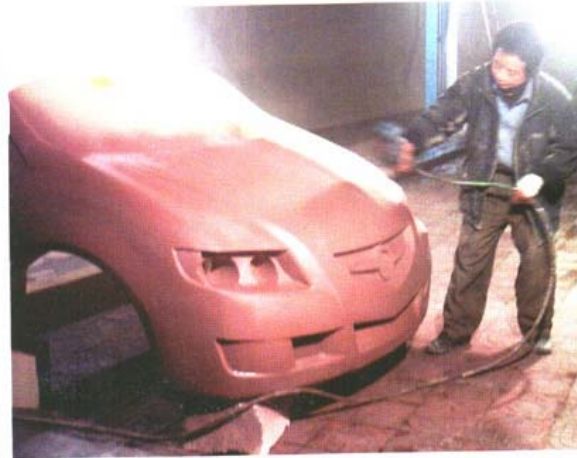

Full Size Foam Model Machined Using a 5-Axis CNC Mill from 3D CAD Model

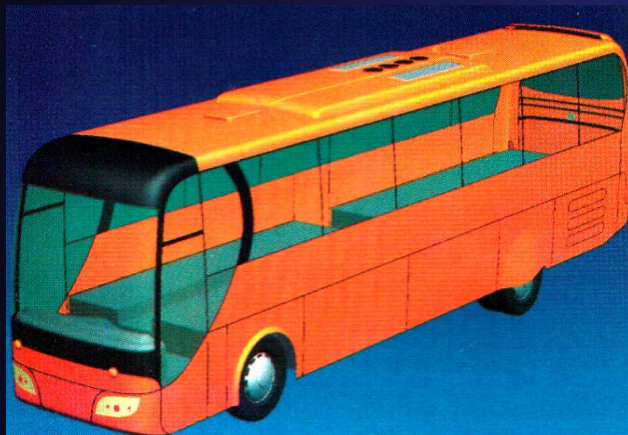
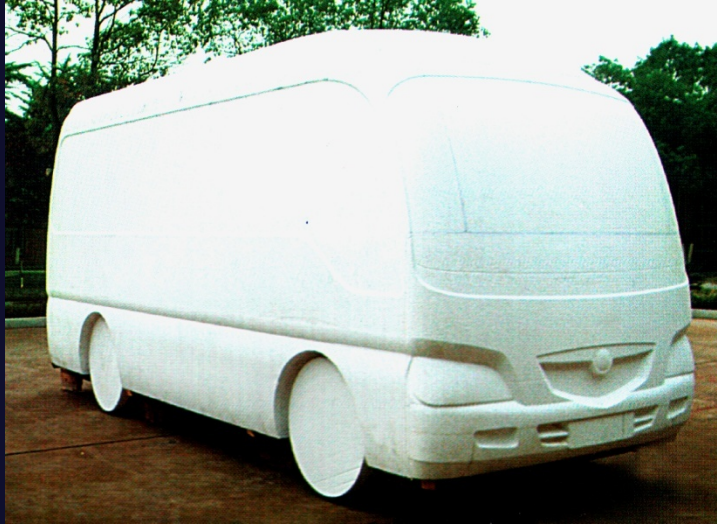

**CAD Model
Regenerated from
3D Scanning**

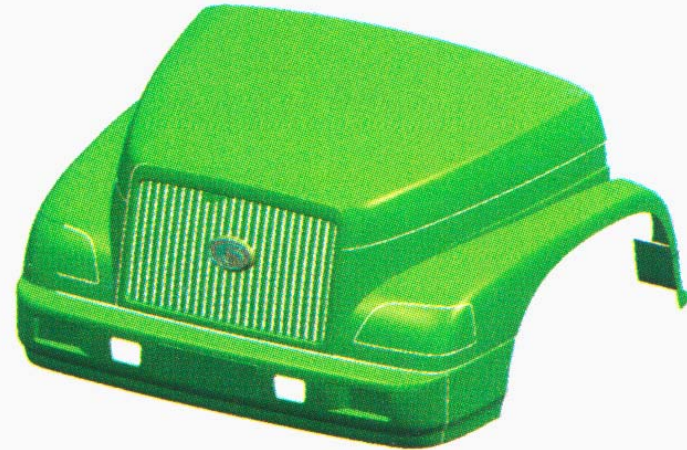

Scanners with Mechanical Probe (Digitizers)



CAD Modeling Based on a 3-D Vision System

- 3D Range Sensors (3D Cameras): **3D Cloud Data Points**
 - **Triangulation-based**: visible laser light, short range, accurate
 - **Time-of-flight-based**: laser light & micro wave, long range, less accurate
- **Processing of 3D Range Data**
 - **3D Cloud Data Points** → Cross-section-based CAD Model
 - Generation of a **Complete Model** of Objects and Workspace
 - by Sensor Fusion
- **Forming a Surface Model and Carrying out Reverse Engineering**
 - Cross-section-based CAD Model → Surface Model → CNC Machining; RP; etc.

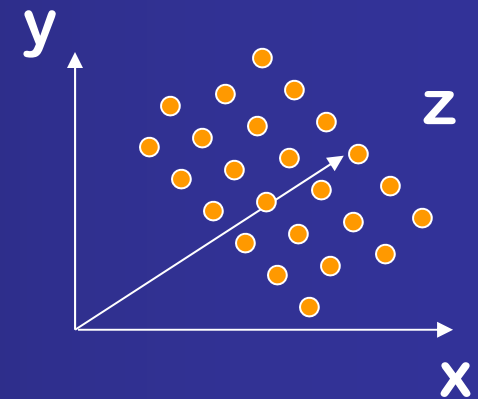

Our Past Researches on Three Dimensional Range Sensing and Object/Workspace Modeling from Multiple Range Images

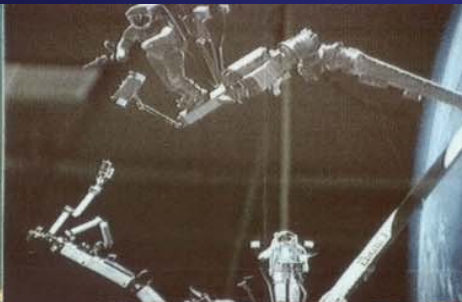
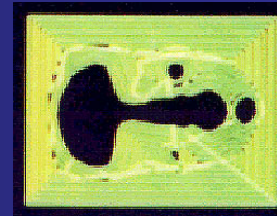
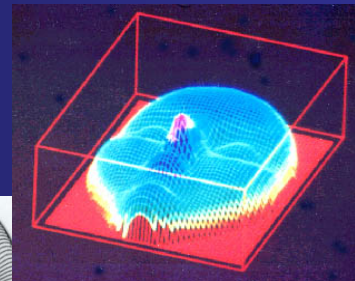
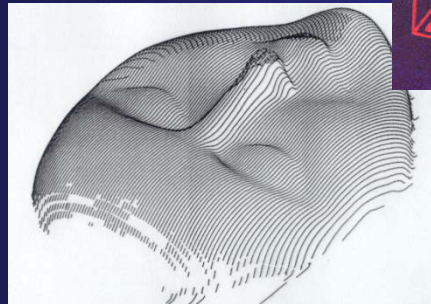

Obtaining 3D Cloud Data Points Using 3D Range Sensors (3D Cameras)

Two Alternatives:

- **Triangulation-based**: visible laser light, short range, accurate
- **Time-of-flight-based**: laser light & micro wave, long range, less accurate

Triangulation-based Range Sensor

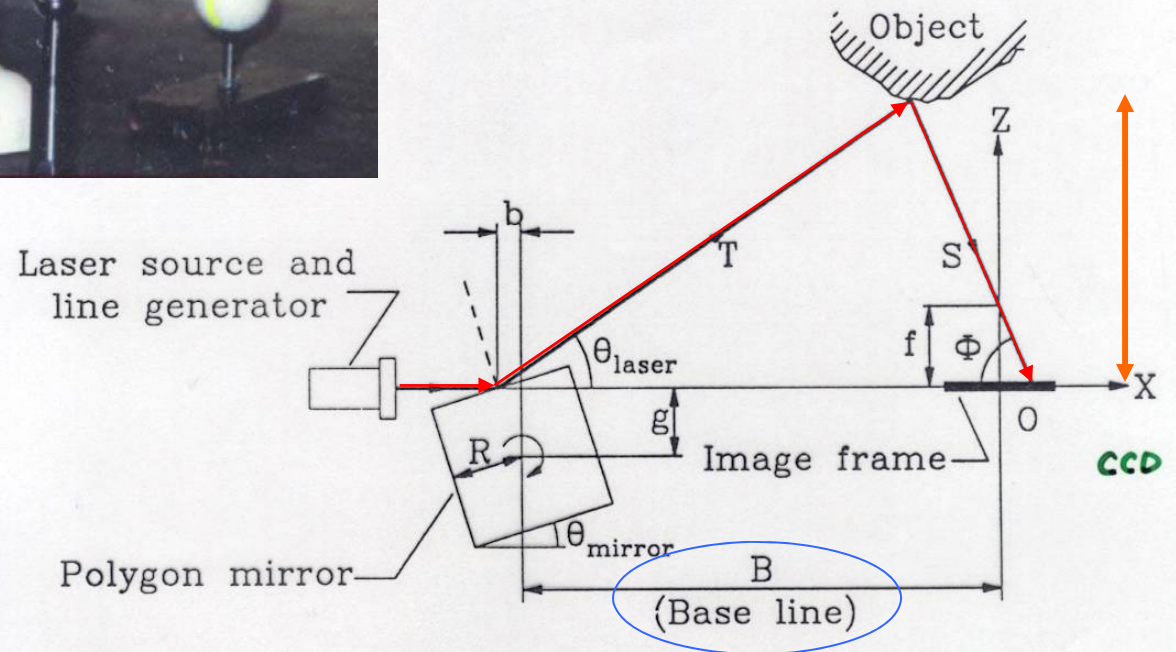

Geometry of a Triangulation-based Range Sensor

Triangulation-based Range Sensor

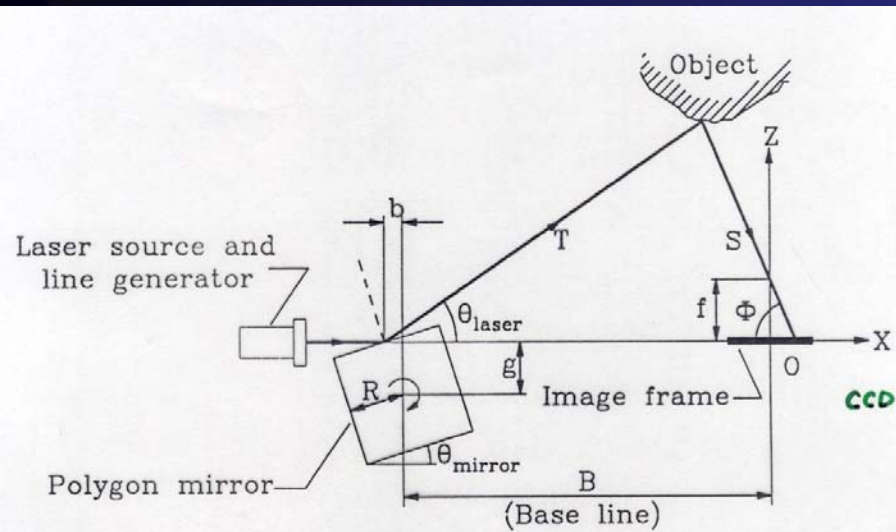

Geometry of a Triangulation-based Range Sensor



calibration

Time of Flight Based Range Sensor

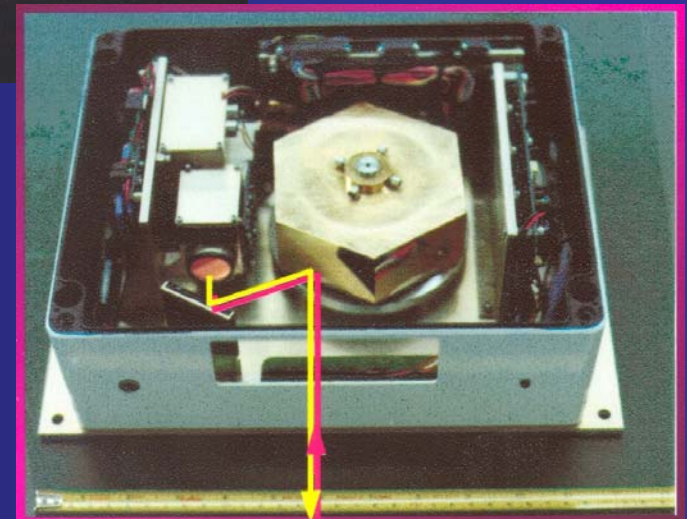
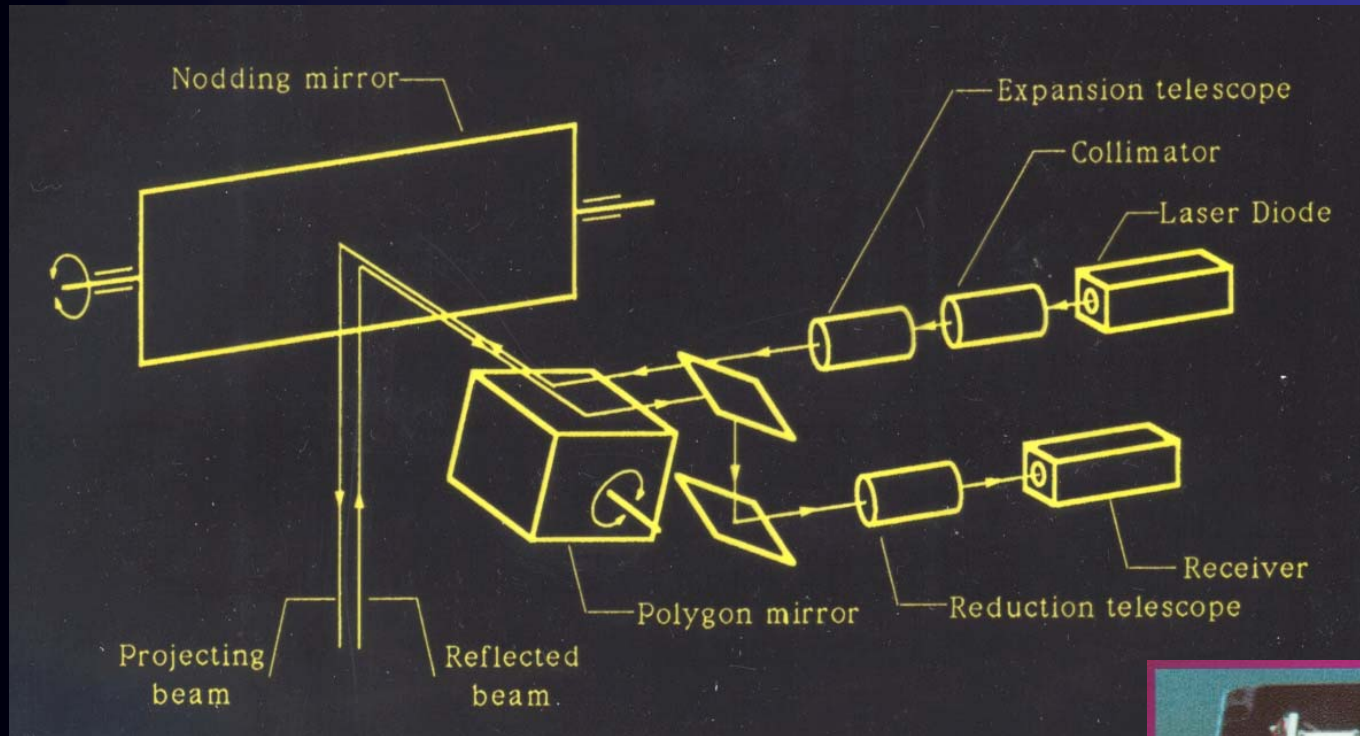

Time of Flight Based Range Sensor

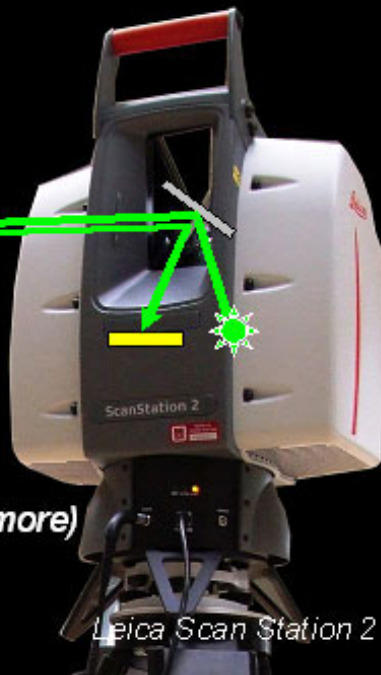

*Long range range (300m or more)
Accuracy (4-6mm)
Data collection (50,000pps)*

Leica Scan Station 2

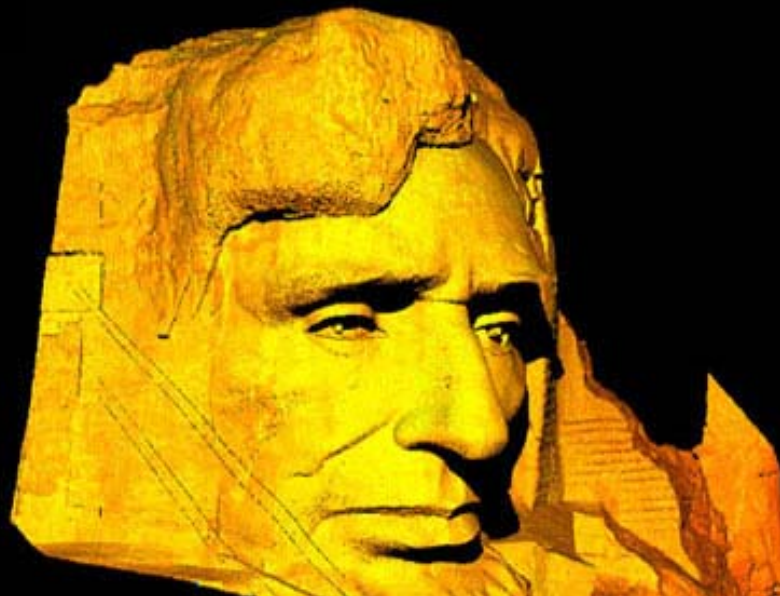

Processing 3D Range Data to Get 3D CAD Models for Reverse Engineering

- Processing of 3D Range Data
 - 3D Cloud Data Points → Cross-section-based CAD Model
 - Generation of a Complete Description for Objects and Workspace by Sensor Fusion
 - Full 3D Surface Model
 - Solid Model of the Scanned Object
- Forming a Surface Model and Carrying out Reverse Engineering
 - Cross-section-based CAD Model → Surface Model
 - CNC Machining; RP; etc.

Multiple View Fusion and Model Integration

Multiple View Fusion and Model Integration

- Unstructured Scanning and Partial Model Generation
- Continuous Modeling and Global Model Update

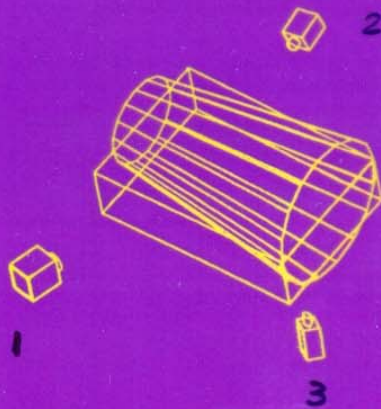

Multiple Sensor Locations

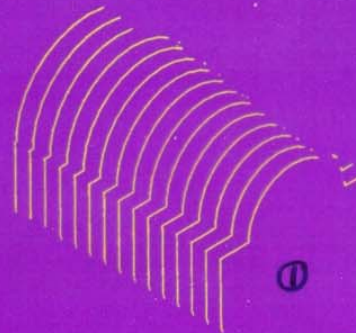
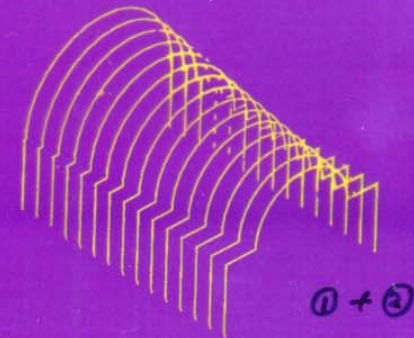
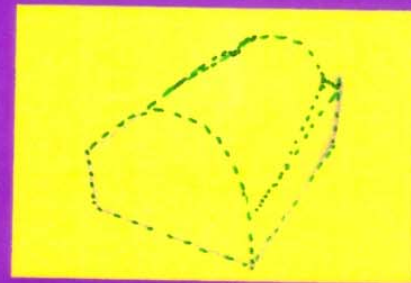

Global Model Formation

Global Model Generation with Multiple View Fusion

An Approach to Generate Geometric Models from Multiple Range Images

Cross-section Model

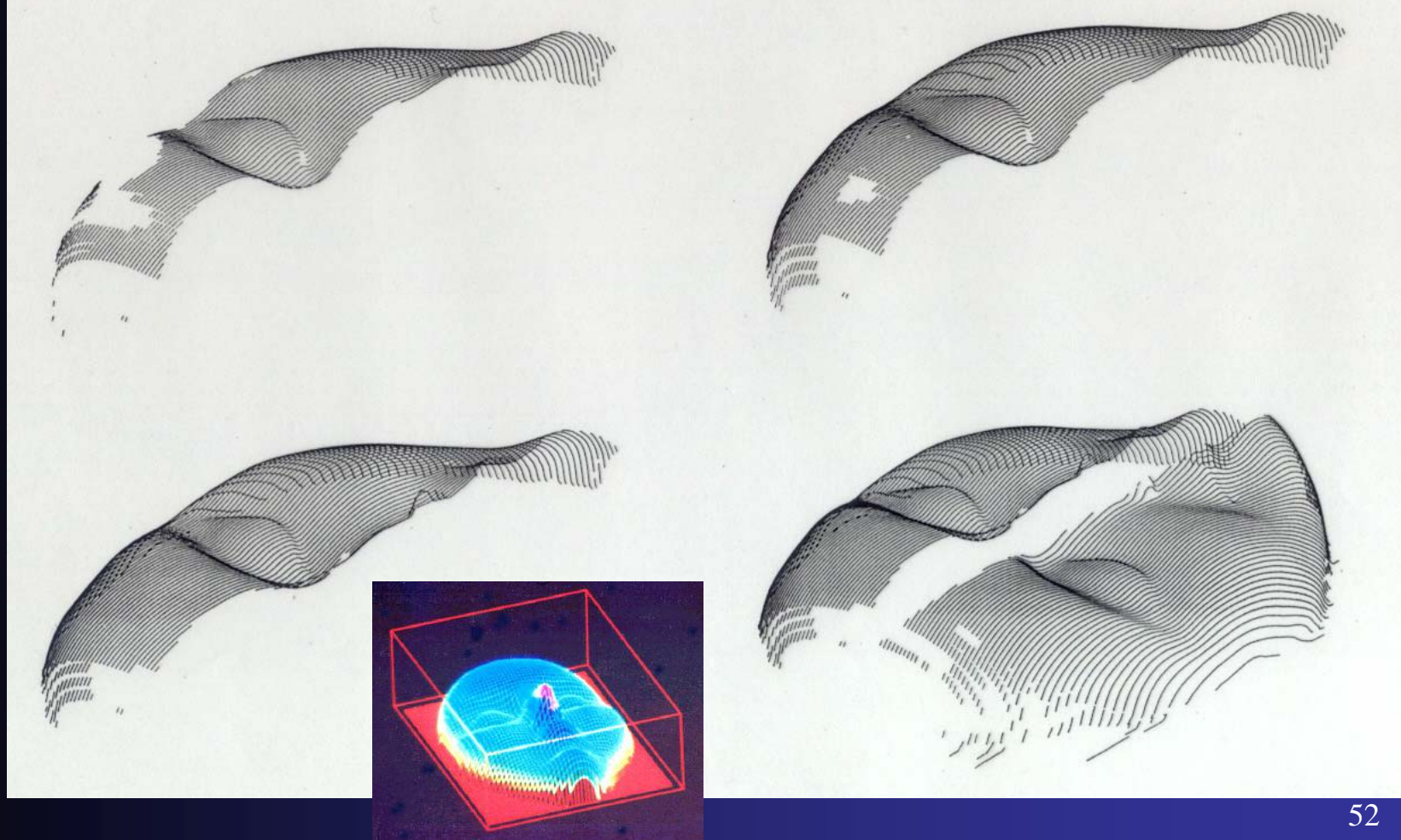

Global Model Generation with Multiple View Fusion

An Approach to Generate Geometric Models from Multiple Range Images

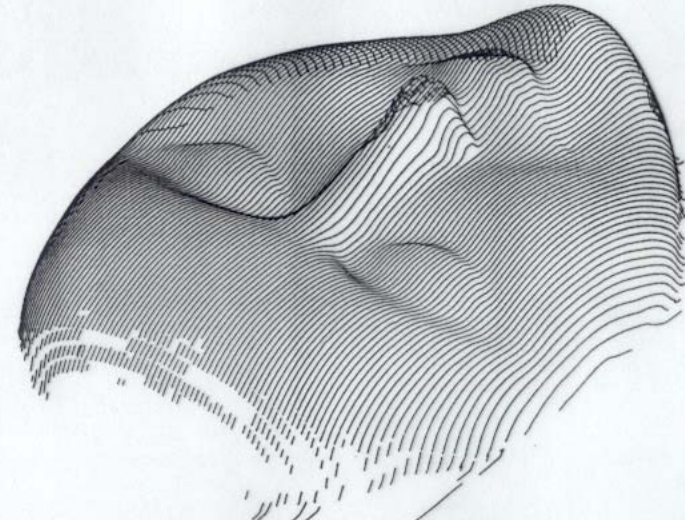
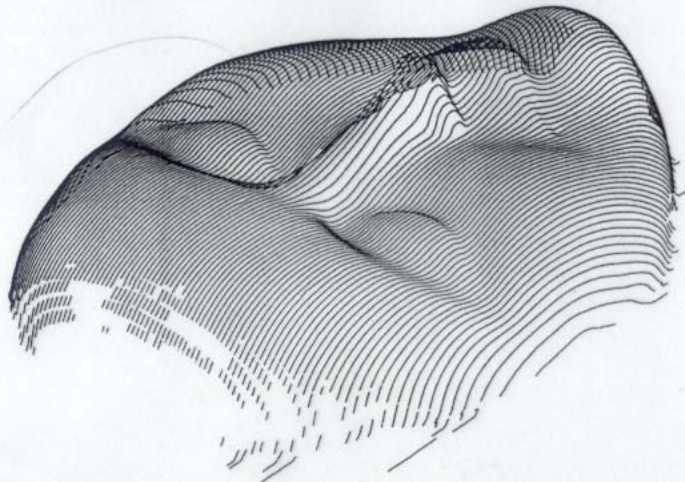
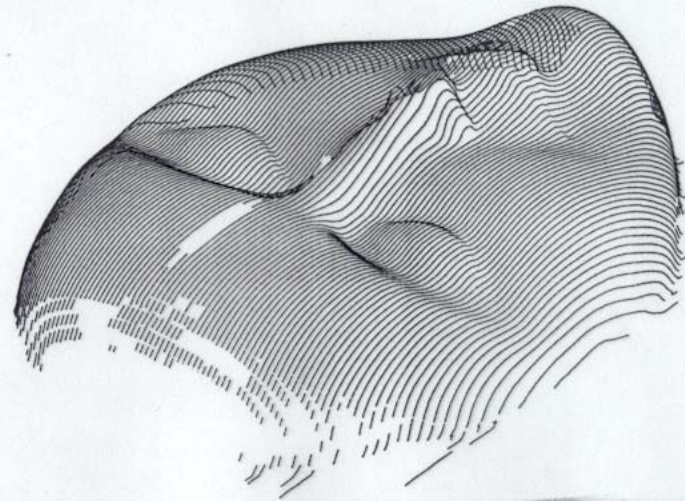
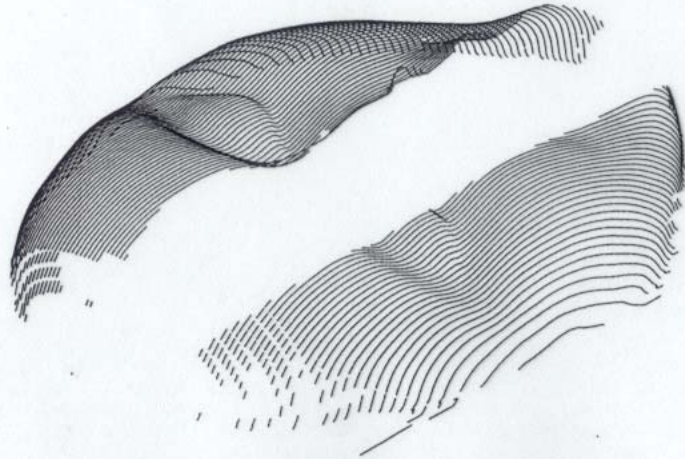

**Automated Real-time Dimension Measurement of
Moving Vehicles Using Infrared Laser
Rangefinders**

Automated Vehicle Dimension Measurement System for Commercial and Oversize Vehicles

- Implemented at BC Ferries Terminal
- Real-time Vehicle **Dimension** Measurement
- Complex Vehicle Shapes
- Dimensions Measured at Speeds up to **120 km/hr**
- Adverse Weather Conditions
- Height and Width Accuracy: 15 cm
- Length Accuracy: 30 cm



Automated Real-time Dimension Measurement of Moving Vehicles Using Infrared Laser Rangefinders

Layout of Ranger and Speed Sensors

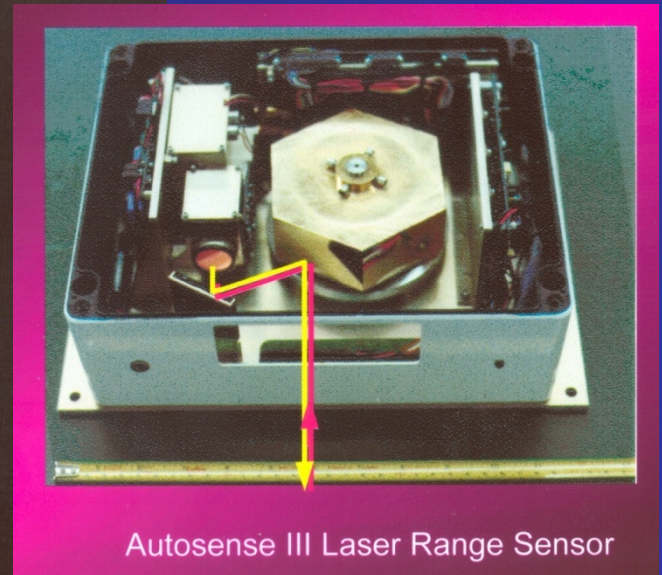
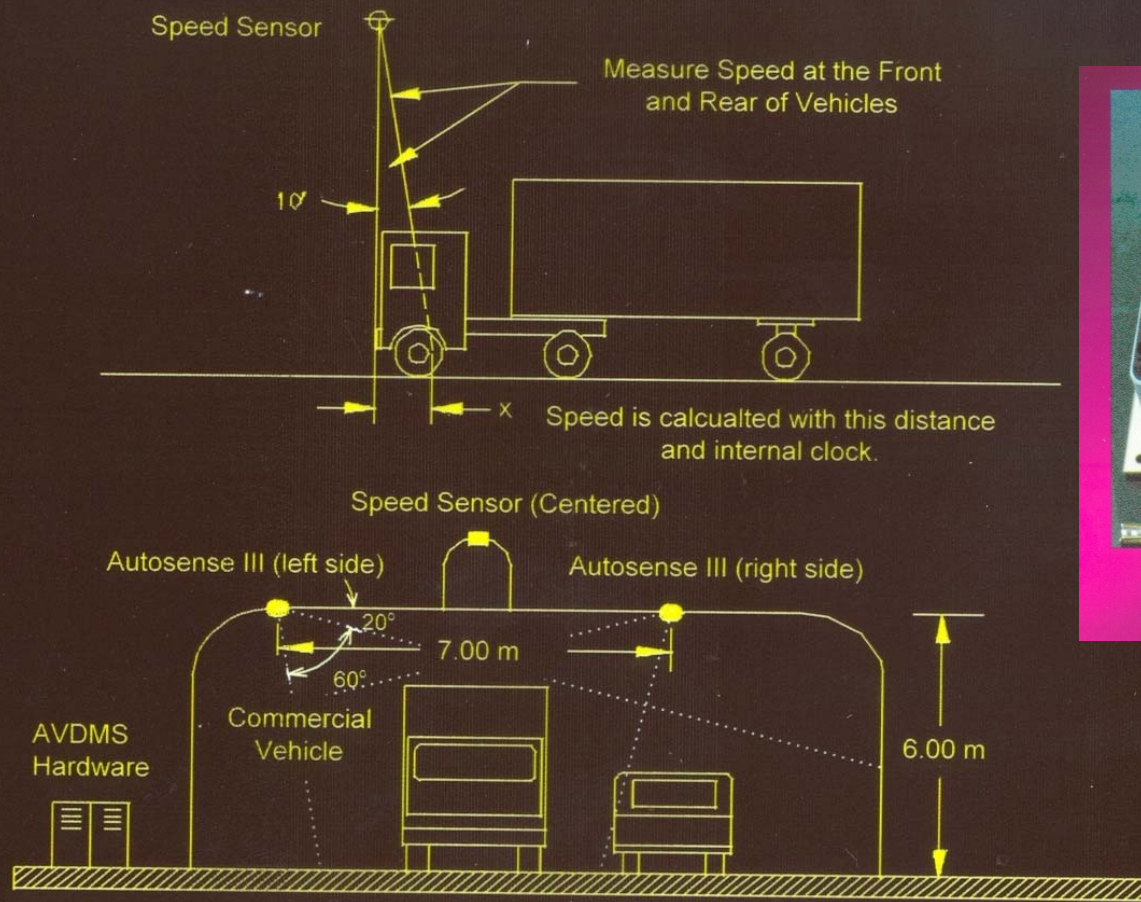

Road Test Site



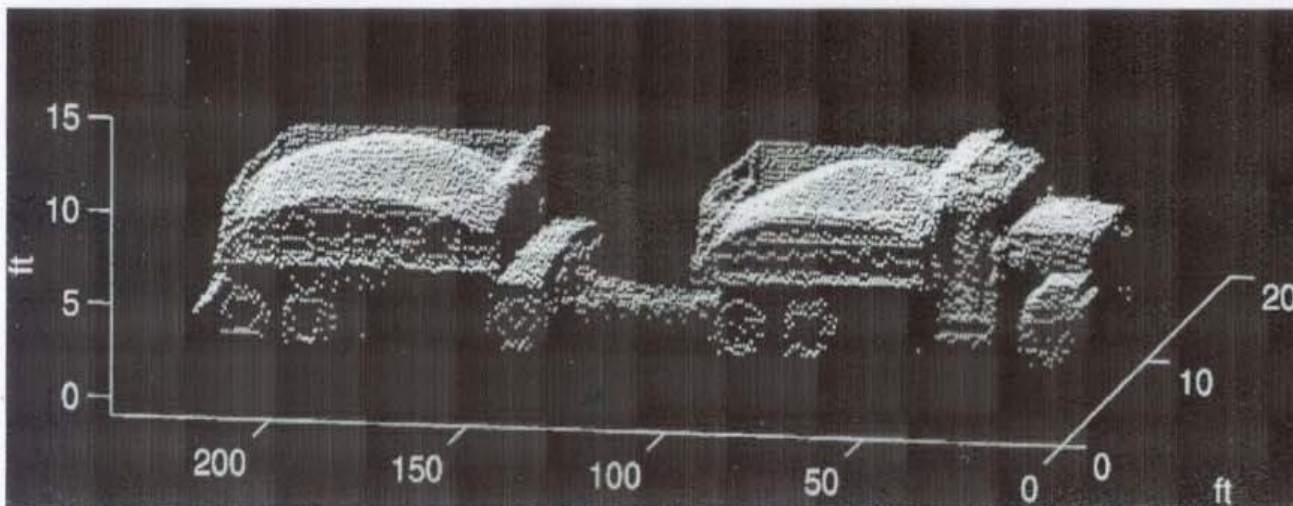

matlab



(a) Photograph of the Vehicle

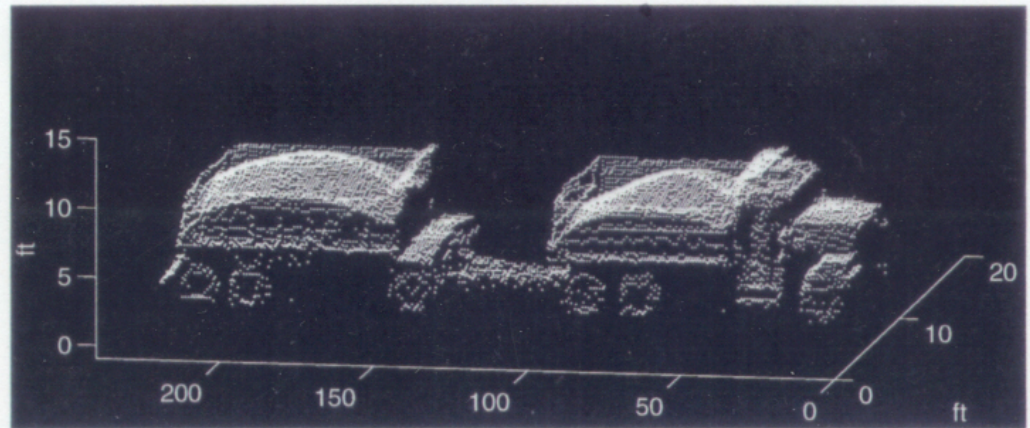

(b) Acquired Range Data of the Vehicle



(a) Photograph of the Vehicle

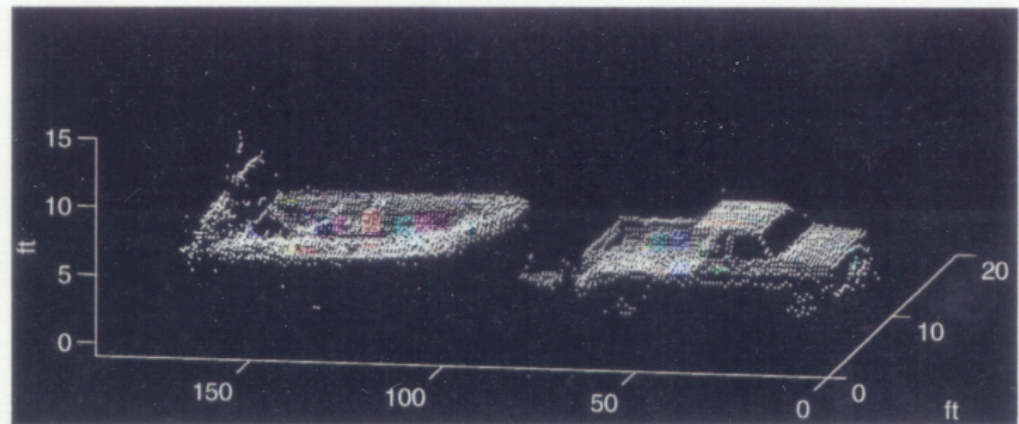

(b) Acquired Range Data of the Vehicle

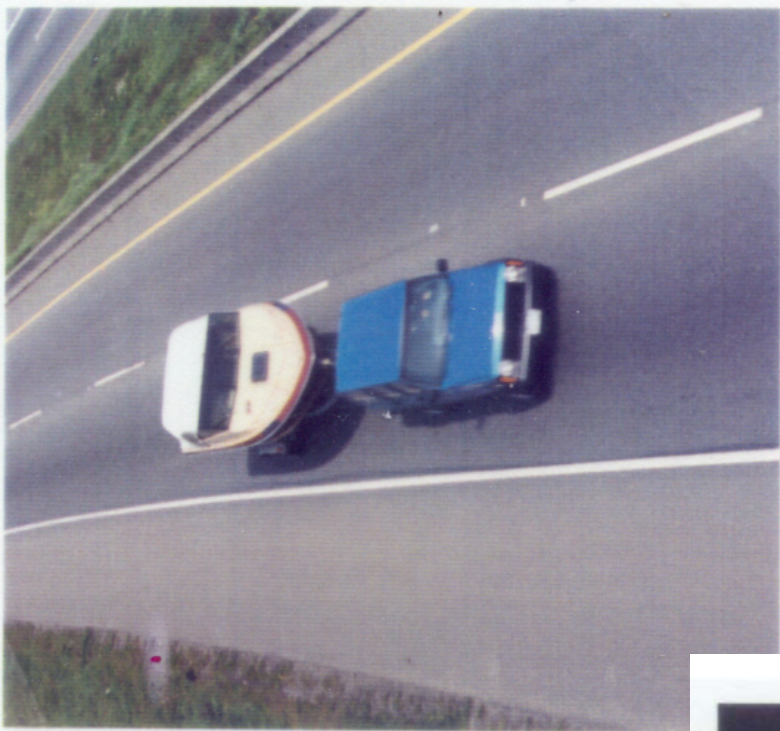

(a) Photograph of the Vehicle

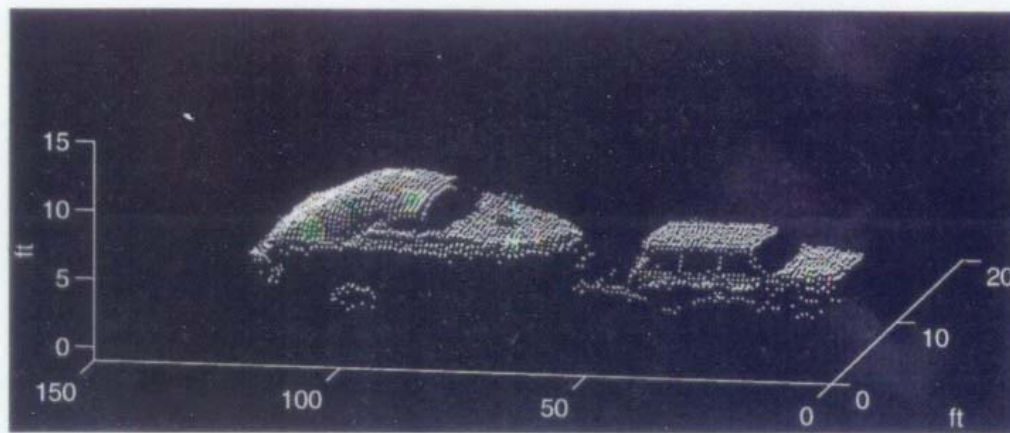

(b) Acquired Range Data of the Vehicle

Reverse Engineering and Automated CNC Tool Path Generation for Efficient and High Quality Sculptured Part Machining

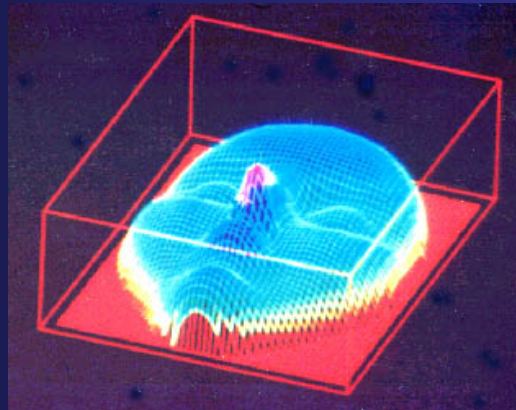
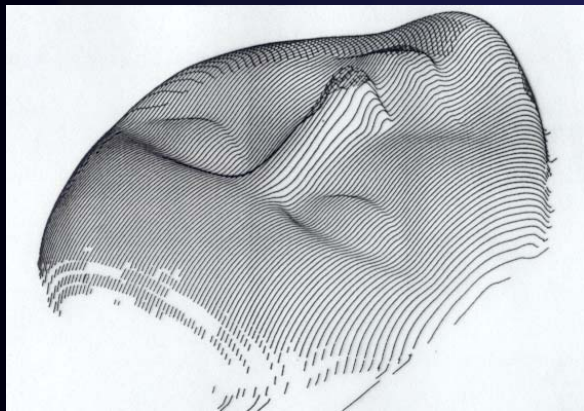
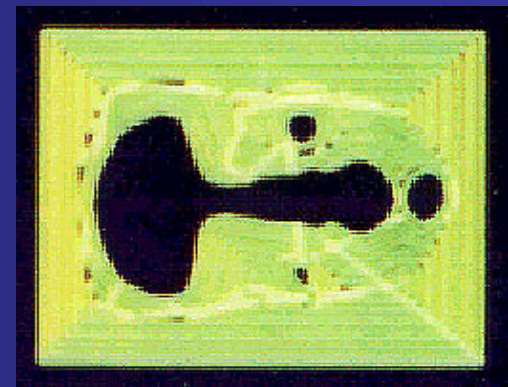
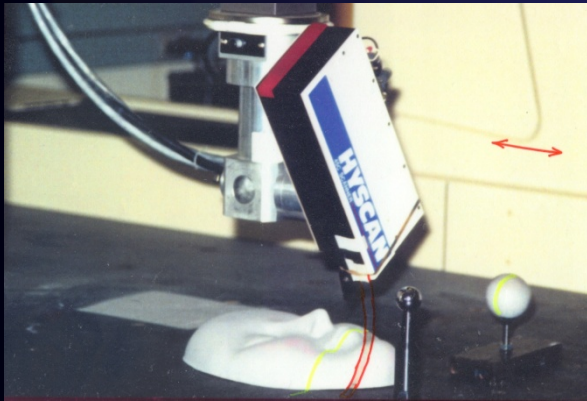

Geometric Modeling Based on 3D Scanning

- **Challenges:**

- Accuracy/Lighting/Range (Selecting **Right 3D Sensing Tech**)
- Occlusion (Obstruction)/Multiple View **Fusion**
- Multiple Level Modeling:
Cloud Data Points → **Cross-sections** → **Surfaces** → **Solid**

- **Applications:**

- Reverse Engineering (e.g. Face Mask)
- Size Measurement (e.g. Moving Vehicle)
- Object Recognition (e.g. Moving Vehicle)
- 3D Sculpture Documentation
- Shoe Making
- Character Modeling in Movies/Computer Games